

# **Assessment of Sockeye and Pink Salmon Stocks in the Northern Boundary Area Using Run Reconstruction Techniques, 1982-95**

W.J.Gazey and K.K. English

Fisheries and Oceans Canada  
Science Branch, Pacific Region  
417 - 2<sup>nd</sup> Ave. W., Room 202  
Prince Rupert, British Columbia  
V3J 1G8

2000

**Canadian Technical Report of  
Fisheries and Aquatic Sciences 2320**



Fisheries and Oceans  
Canada

Science

Pêches et Océans  
Canada

Sciences

**Canada**

## **Canadian Technical Report of Fisheries and Aquatic Sciences**

Technical reports contain scientific and technical information that contributes to existing knowledge but which is not normally appropriate for primary literature. Technical reports are directed primarily toward a worldwide audience and have an international distribution. No restriction is placed on subject matter and the series reflects the broad interests and policies of the Department of Fisheries and Oceans, namely, fisheries and aquatic sciences.

Technical reports may be cited as full publications. The correct citation appears above the abstract of each report. Each report is abstracted in *Aquatic Sciences and Fisheries Abstracts* and indexed in the Department's annual index to scientific and technical publications.

Numbers 1 - 456 in this series were issued as Technical Reports of the Fisheries Research Board of Canada. Numbers 457 - 714 were issued as Department of the Environment, Fisheries and Marine Service Technical Reports. The current series name was changed with report number 925.

Technical reports are produced regionally but are numbered nationally. Requests for individual reports will be filled by the issuing establishment listed on the front cover and title page. Out-of-stock reports will be supplied for a fee by commercial agents.

## **Rapport technique canadien des sciences halieutiques et aquatiques**

Les rapports techniques contiennent des renseignements scientifiques et techniques qui constituent une contribution aux connaissances actuelles, mais que ne sont pas normalement appropriés pour la publication dans un journal scientifique. Les rapports techniques sont destinés essentiellement à un public international et ils sont distribués à cet échelon. Il n'y a aucune restriction quant au sujet; de fait, la série reflète la vaste gamme des intérêts et des politiques du ministère des Pêches et des Océans, c'est-à-dire les sciences halieutiques et aquatiques.

Les rapports techniques peuvent être cités comme des publications complètes. Le titre exact paraît au-dessus du résumé de chaque rapport. Les rapports techniques sont résumés dans la revue *Résumés des sciences aquatiques et halieutiques*, et ils sont classés dans l'index annuel des publications scientifiques et techniques du Ministère.

Les numéros 1 à 456 de cette série ont été publiés à titre de rapports techniques de l'Office des recherches sur les pêcheries du Canada. Les numéros 457 à 714 sont parus à titre de rapports techniques de la Direction générale de la recherche et du développement, Service des pêches et de la mer, ministère de l'Environnement. Les numéros 715 à 924 ont été publiés à titre de rapports techniques du Service des pêches et de la mer, ministère des Pêches et de l'Environnement. Le nom actuel de la série a été établi lors de la parution du numéro 925.

Les rapports techniques sont produits à l'échelon regional, mais numérotés à l'échelon national. Les demandes de rapports seront satisfaites par l'établissement auteur dont le nom figure sur la couverture et la page du titre. Les rapports épuisés seront fournis contre rétribution par des agents commerciaux.

Canadian Technical Report of  
Fisheries and Aquatic Sciences 2320

2000

**ASSESSMENT OF SOCKEYE AND PINK SALMON STOCKS  
IN THE NORTHERN BOUNDARY AREA  
USING RUN RECONSTRUCTION TECHNIQUES, 1982-95**

by

W.J. Gazey<sup>1</sup> and K.K. English<sup>2</sup>

Fisheries and Oceans Canada  
417 – 2<sup>nd</sup> Ave. W., Room 202  
Prince Rupert, British Columbia  
V3J 1G8

<sup>1</sup> W.J. Gazey Research  
1214 Camas Court  
Victoria, British Columbia  
V8X 4R1

<sup>2</sup>LGL Limited  
9768 Second Street  
Sidney, British Columbia  
V8L 3Y8

Her Majesty the Queen in Right of Canada, 2000,  
As represented by the Minister of Fisheries and Oceans,  
Cat. No. FS 97-6/2320E ISSN 0706-6457

Correct citation for this publication:

Gazey, W.J. and K.K. English. 2000. Assessment of sockeye and pink salmon stocks in the northern boundary area using run reconstruction techniques, 1982-95. Can. Tech. Rep. Fish. Aquat. Sci. 2320: 132 p.

## TABLE OF CONTENTS

LIST OF TABLES .....	v
LIST OF FIGURES .....	vii
LIST OF APPENDICES .....	viii
ABSTRACT .....	ix
RÉSUMÉ .....	x
INTRODUCTION .....	1
DATA SOURCES AND PREPARATION .....	1
Stock and Fishery Definitions.....	1
Catch.....	2
Canadian Fisheries.....	2
Alaskan Fisheries .....	3
Escapement .....	4
Northern B.C. Stocks .....	4
Southern B.C. Sockeye Stocks.....	4
Alaskan Stocks .....	5
Migration Routes.....	5
Residency Time .....	6
Stock Composition in Alaskan Areas from Scales .....	6
ANALYTICAL METHODS .....	6
Reconstruction Algorithm .....	6
Indices and Variables.....	7
Core Algorithm .....	8
Reconstruction Algorithm for Catch by Stock Group .....	9
Reconstruction Algorithm For Variable Catch Accumulations.....	10
Bisection Algorithm for One Fishery .....	11
Bisection Algorithm for Two Fisheries.....	12
Migration Route Specification .....	13
Parameterization of Migration Routes with Mark-Recapture Data .....	14
Reconstruction of Sockeye Salmon.....	16
Reconstruction of Pink Salmon .....	17
Sensitivity .....	17

**TABLE OF CONTENTS (cont'd)**

RESULTS.....18  
    Sockeye.....18  
    Pink.....20  
    Sensitivity.....23

DISCUSSION.....23

ACKNOWLEDGEMENTS .....26

LITERATURE CITED .....27

TABLES .....29

FIGURES.....54

APPENDICES .....61

## LIST OF TABLES

Table 1.	Definition of Canadian fisheries based on hail survey data.....	30
Table 2.	Definition of Alaskan fisheries based on Pella et al. (1993).....	31
Table 3.	Definition of sockeye and pink salmon stocks included in run reconstructions .....	32
Table 4.	Total annual sockeye catch by fishery and escapement by stock.....	33
Table 5.	Comparison of tagging study estimates of migration proportions with the routing parameters used in the run reconstructions for Skeena and Nass sockeye stocks .....	34
Table 6.	Comparison of sockeye stock interception estimates derived from tagging and run reconstruction.....	35
Table 7.	Percent of stock that passes through each fishery in the absence of fishing during 1982 and 1983 .....	36
Table 8.	Estimates of total run size and exploitation rates for sockeye stocks derived using two approaches: 1) assuming equal vulnerability; and 2) using all available stock composition estimates for Alaskan fisheries derived from scale data.....	37
Table 9.	Differences for sockeye stocks between the run reconstruction results based on equal vulnerability and those derived using scale data, expressed as a percent of the estimates based on equal vulnerability.....	38
Table 10.	Percent contribution of Alaskan sockeye stocks to northern boundary fisheries.....	39
Table 11.	Canadian balance of sockeye salmon catch in northern boundary fisheries derived using two types of run reconstructions: 1) assuming equal vulnerability; and 2) using scale data for Alaskan fisheries .....	40
Table 12.	Comparison of the Canadian interception balance for sockeye salmon derived from run reconstruction results with estimates computed by the Pacific Salmon Commission Joint Interception Committee (JIC, 1993) .....	41

**LIST OF TABLES (cont'd)**

Table 13.	Total annual pink salmon catch by fishery .....	42
Table 14.	Total annual pink salmon escapement by stock.....	43
Table 15.	Comparison of tagging study estimates of migration proportions with the routing parameters used in the run reconstructions for Skeena and US101 pink salmon stocks .....	44
Table 16.	Comparison of tagging study and run reconstruction estimates of pink salmon stock composition in northern boundary fisheries.....	45
Table 17.	Summary of the differences between the tagging study and run reconstruction estimates of pink salmon stock composition for each northern boundary fishery .....	47
Table 18.	Percent of pink salmon stocks that pass through each fishery in the absence of fishing .....	48
Table 19.	Estimates of total annual run size and harvest rates for each pink salmon stocks .....	49
Table 20.	Percent contribution of Alaska pink salmon stocks to northern boundary fishery .....	50
Table 21.	Canadian balance for pink salmon catch in northern boundary fisheries .....	51
Table 22.	Comparison of the Canadian interception balance for pink salmon derived from run reconstruction with estimates computed by the Pacific Salmon Commission Joint Interception Committee (JIC, 1998) .....	52
Table 23.	Change in sockeye catch interception estimates from application of inappropriate migration route proportions .....	53



**LIST OF FIGURES**

Figure 1.	Geographic location of major fisheries in the northern boundary area .....	55
Figure 2.	Comparison of stock size estimates for sockeye stocks using two run reconstruction approaches .....	56
Figure 3.	Comparison of the Canadian interception balance for sockeye salmon derived from run reconstruction results with estimates computed by the Pacific Salmon Commission Joint Interception Committee (JIC, 1998) .....	57
Figure 4.	Annual stock size estimates for pink salmon stocks derived from run reconstruction.....	58
Figure 5.	Comparison of the Canadian interception balance for pink salmon derived from run reconstruction results with estimates computed by the Pacific Salmon Commission Joint Interception Committee (JIC, 1998) .....	59
Figure 6.	Results of a 1000 Monte Carlo trials of the 1983 sockeye salmon reconstruction.....	60

**LIST OF APPENDICES**

Appendix A. Area-under-the-curve Method.....	62
Appendix B. Sockeye Migration Routing Parameters .....	65
Appendix C. Sockeye Migration Routing Diagrams .....	70
Appendix D. Sockeye Catch by Stock, 1982-95 .....	77
Appendix E. Differences Between Two Alternative Sockeye Run Reconstructions, 1982-95 .....	92
Appendix F. Pink Salmon Migration Routing Parameters.....	107
Appendix G. Pink Salmon Migration Routing Diagrams.....	111
Appendix H. Pink Salmon Catch by Stock, 1982-95.....	118

**ABSTRACT**

Gazey, W.J. and K.K. English. 2000. Assessment of sockeye and pink salmon stocks in the northern boundary area using run reconstruction techniques, 1982-95. *Can. Tech. Rep. Fish. Aquat. Sci.* 2320: 132 p.

A multi-time-period method of stock reconstruction was used to estimate harvest and stock interception rates by area and time period, exploitation rates and total run size by stock. The data required for these reconstructions were catch by time and area, daily escapement by population (stock), the residence time of each population in each harvest area, and the routing of the populations. Migration routes for each stock were defined using information from the 1982-85 north coast tagging studies. The initial set of migration routing parameters were adjusted until the run reconstruction results approximated those from the tagging study years. Two different sets of migration parameters were required to fit the 1982 and 1983 interception rates for sockeye. While the 1983 set provided the best fit to the interception rates for Alaskan fisheries based on scale data for 1984-95, year to year variability can be substantial. Consequently, we incorporated all the available stock composition estimates for Alaskan fisheries into our sockeye reconstruction analysis. Limited sensitivity analysis on sockeye indicated that uncertainty in migration parameters has a greater effect on stock size estimates than interception rates. For pink salmon, one set of migration parameters was defined that approximated the tagging study results for 1982, 1984 and 1985. Substantial changes in the annual abundance of major pink salmon stocks appears to explain most of the variability observed in the tagging study interception rates. Comparison of the Canadian interception balance computed from the run reconstructions with estimates produced by the Joint Interception Committee revealed good agreement for sockeye but some substantial differences for pink salmon. Both methods used the same total escapement estimates; however, the current JIC method does not take into account the relative abundance of each Alaskan pink salmon stock and the sequence of fishery harvests. Further examination of the escapement estimates and JIC procedures for pink salmon is recommended.

## RÉSUMÉ

Gazey, W.J. and K.K. English. 2000. Assessment of sockeye and pink salmon stocks in the northern boundary area using run reconstruction techniques, 1982-95. Can. Tech. Rep. Fish. Aquat. Sci. 2320: 132 p.

Nous avons eu recours à une méthode multipériodes de reconstruction des stocks pour estimer le taux de capture et le taux d'interception par zone et par période, le taux d'exploitation et l'effectif total de la remonte par stock. Les données nécessaires pour ces reconstructions étaient les captures par période et par zone, l'échappée quotidienne par population (stock), le temps de résidence de chaque population dans chaque zone de capture et l'itinéraire des populations. Nous avons défini les voies de migration de chaque stock grâce à l'information fournies par les études de marquage menées sur la Côte Nord de 1982 à 1985. La série initiale de paramètres de migration a été ajustée jusqu'à ce que les résultats de la reconstruction approchent ceux des années de l'étude sur le marquage. Deux différentes séries de paramètres de migration ont été nécessaires pour ajuster les taux d'interception de 1982 et 1983 pour le saumon rouge. Si la série de 1983 a fourni le meilleur ajustement pour les taux d'interception des pêches de l'Alaska à partir des données sur les écailles recueillies de 1984 à 1995, la variabilité d'une année à l'autre peut être importante. En conséquence, nous avons intégré à notre analyse de reconstruction des stocks de saumon rouge toutes les estimations disponibles sur la composition des stocks dans les pêches de l'Alaska. Une analyse limitée de sensibilité menée sur le saumon rouge a indiqué que l'incertitude dans les paramètres de migration a un plus grand effet que les taux d'interception sur l'estimation de la taille du stock. Pour le saumon rose, nous avons défini une série de paramètres de migration qui approchait les résultats de l'étude de marquage pour les années 1982, 1984 et 1985. Des changements substantiels dans l'abondance annuelle des principaux stocks de saumon rose semblent expliquer la plus grande partie de la variabilité observée dans les taux d'interception de l'étude de marquage. La comparaison du bilan des interceptions canadiennes calculé à partir des reconstructions de la remonte avec des estimations produites par le Comité mixte sur les interceptions a révélé une bonne concordance pour le saumon rouge mais certaines différences notables pour le saumon rose. Les deux méthodes employaient les mêmes estimations des échappées totales; toutefois, la méthode utilisée actuellement par le Comité ne tient pas compte de l'abondance relative de chaque stock de saumon rose de l'Alaska ni de la chronologie des captures. Nous recommandons de poursuivre l'examen des estimations des échappées et des procédures du Comité pour le saumon rose.

## INTRODUCTION

A substantial amount of information has been accumulated on northern boundary sockeye and pink salmon stocks and fisheries over the past fifteen years. In 1993, the Department of Fisheries and Oceans and the Nisga'a Tribal Council initiated a project to compile detailed catch and escapement data and combine it with information on migration routes and travel times using run reconstruction techniques. The resulting stock specific estimates of abundance, contributions to fisheries, harvest rates and run timing are critical information for the resolution of issues associated with the Canada/U.S. Salmon Treaty, assessment of stock status and the future management of northern boundary fisheries.

In this report we describe data, analytical methods and results from reconstructions for sockeye and pink salmon returns from 1982-95. The rigorous reconstruction of northern boundary salmon runs requires a substantial amount of information and a detailed understanding of the region's stocks and fisheries. Consequently, a large portion of our time was devoted to organizing and analyzing catch, escapement, run timing, migration route, and stock composition data for sockeye and pink salmon in the northern boundary area. An earlier report presenting preliminary results for 1982-92 was reviewed by the Pacific Region Stock Assessment Review Committee (PSARC) and circulated to Alaska fisheries managers in 1996. All comments received have been address in this report. These consultations with senior fisheries managers and scientists from Canada and Alaska has provide valuable opportunity to exchange ideas, discuss data limitations and evaluate our preliminary results. We look forward to this process continuing as our understanding of these stocks and fisheries evolves.

The multi-time-period method of stock reconstruction described in this report is applicable to salmon gauntlet fisheries that are typically scheduled over several weeks, in different fishing areas, and harvest many stocks. The data required by the method are catch by time and area, escapement by time and population (stock), the residence time of each population in each harvest area, and the routing of the populations. The method may be used to estimate harvest and stock interception rates by area and time period, exploitation rate and total (entering) run size by population. The specific populations (stocks) of pink and sockeye salmon, the harvesting areas and the time resolution serve to scope the reconstruction model. We will relate the rationale for this "scope" below.

## DATA SOURCES AND PREPARATION

### Stock and Fishery Definitions

The stock and fishery definitions were determined from the following sources: (1) management units of populations (stocks) and areas (fisheries) as defined by Department of Fisheries and Oceans (DFO) and Alaska Department of Fish and Game (ADF&G) personnel, (2) resolution of stocks and fisheries consistent with previous North Coast mark-recapture studies (Gazey et al. 1983, English et al. 1984, 1985a, Taylor et al. 1986 in B.C. and Pella et al. 1993 in Alaska). The definition of Canadian and Alaskan fisheries are provided in Tables 1 and 2, respectively. The general geographic location for each fishery is displayed in Fig. 1. Note that

the mixed stock sub-area 3-7-2 (below China Hat), located in Statistical Area 3z, was combined with the adjacent Statistical Area 3y to form a fishery we have termed "3y+7". The remainder of Area 3z targets only on the Nass River stock (i.e., a terminal fishery). We have designated this area as "3z-7". The sockeye stock designated as "South" represents all Canadian stocks south of the North Coast region (essentially Fraser River sockeye). The source and assignment of catch and escapement to these fisheries and stocks is described in detail below.

## **Catch**

The data and procedures used to prepare the catch data for run reconstructions was very different for Canadian and Alaskan fisheries. In Canadian gillnet and seine fisheries, the official weekly catch statistics were allocated to specific days using fisheries officer hail data. Canadian troll data were organized by week because there were no reliable estimates for daily troll catch. In Alaska, all catch data were organized by fishery openings which ranged from 1 to 7 days but tended to be 2-3 days in duration. Since the run reconstruction model operates on a daily time step and was designed to handle fisheries of varying duration the above inconsistencies in catch data were accommodated.

## **Canadian Fisheries**

The bulk of the work associated with preparing the catch data for Canadian fisheries was associated with the collection, organization and verification of the fisheries officer hail data. Most of this information was not available in digital form and it had to be extracted from hand written tables or DFO internal reports (e.g., Annual Management Reports). The compiled hail data includes daily estimates of fishing effort and catch for each salmon species stratified by sub-statistical area and gear type. Official weekly catch statistics by species, statistical area and gear type were obtained from DFO's Sale Slip Catch Database. For statistical areas 1, 3 and 4, official weekly catch statistics were prorated to specific days and sub-areas using the hail data. The relationship between the sub-areas defined in the hail data and the fisheries in our run reconstruction model is provided in Table 1. Since our model defines Area 5 as a single fishery, the Area 5 hail data was summed for the whole area and used to prorate the official catch statistics to specific days. In a few instances, hail data were not available for small fisheries early or late in the season. We assumed that the openings were confined to a single day and we allocated the entire catch to the first day of the catch week. These catch records can be readily identified in the database because the boat count estimates, normally derived from the hail data, are missing.

The lack of detailed hail data sub-areas within Area 3 and 4 in 1982-84 required additional analysis and assumptions to partition the weekly catch to our run reconstruction fisheries. In Area 3, the 1982-84 hail data did not provide a breakdown of the harvests above and below China Hat (the boundary between our 3y+7 and 3z-7 fisheries). Analysis of the detailed hail data for Area 3 from 1985-92 revealed that: (1) the majority of the sockeye harvested by seine vessels in

Area 3z takes place in the portion of Area 3-7 below China Hat; and (2) the sockeye harvested by seine gear above China Hat was roughly equivalent to the sockeye harvested by gillnet gear below China Hat.

Consequently, we assigned all the Area 3z sockeye harvest by seine gear to our Area 3y+7 fishery and all the Area 3z sockeye harvest by gillnet gear to our Area 3z-7 fishery, for 1982-84. This assumes that the distributions sockeye harvests by gear type in Area 3-7 in 1982-84 was similar to that observed during 1985-92.

In Area 4, the 1982-84 the daily hail data did not provide a breakdown of harvests by sub-areas. However, aerial survey counts of fishing vessels by sub-area were available and could be used to partition catch by sub-area if we could assume equal catch rates throughout Area 4. Since analysis of the 1985-92 Area 4 hail data did not reveal consistent significant differences in the catch rates between sub-areas, we accepted the assumption of equal catch rates between sub-areas and allocated the weekly harvest based on the distribution of fishing vessels determined from aerial surveys.

All of the above assumptions were discussed with DFO's North Coast management biologist's and it was agreed that the resulting catch estimate would provide the best approximation of the daily harvest by sub-area and gear type obtainable from the existing data (Dave Peacock, DFO Prince Rupert, pers. comm.).

### Alaskan Fisheries

Initial discussions with ADF&G staff quickly determined that the data require to apportion weekly Alaskan harvest to specific days were not available. However, the Alaskan Commercial Fisheries Catch database did provide a detailed record of the harvest by landing date and sub-area along with a digital record of the opening and closing dates for each fishery (sub-area and gear type) in southern southeast Alaska. Given these data we examined the potential of assigning harvests to fishery openings based on the landing date. This examination revealed that 98% of the harvests from a specific sub-area were landed during a period when that sub-area was open and most of the remaining harvest was landed within two days of the closing date for a specific fishery. We discussed these observations with ADF&G representatives and it was agreed that a reasonable approach would be to assign all harvests landed during an opening, or within two days of the closing date, to the fishing period defined by these open and closing dates.

Once harvests were allocated to a specific sub-district and fishing period by gear type the only remaining task was to combine the sub-district harvests into the fisheries defined for the run reconstructions. Following recommendations from ADF&G representatives our definition of Alaskan fisheries was effectively identical to that used in the Alaskan analysis of the 1982-85 adult salmon tagging program (Pella et al. 1993). The list of Alaska fisheries and associated sub-districts is provided in Table 2.

## **Escapement**

A list of the sockeye and pink salmon stocks included in the model is provided in Table 3. Two types of information on escapement were obtained for each stock: 1) the annual estimates of total escapement for 1982-95; and 2) year specific or average annual estimates of the escapement run timing for each stock. These two types of information were combined to compute estimates of the daily escapement for each stock. In our run reconstructions these estimates represent the total daily escapement from ocean fisheries, therefore, for some stocks (e.g., Nass, Skeena and Stikine) these escapement estimates include harvests taken in river fisheries.

### **Northern B.C. Stocks**

The total annual escapement estimates for most northern B.C. sockeye and pink stocks were obtained from Les Jantz, DFO Prince Rupert. Estimates of escapement run timing for Nass sockeye, Stikine sockeye and Skeena sockeye and pink salmon were obtained from test fisheries operated near the mouth of these rivers. Escapement timing estimates for even year pink salmon returns to the Yakoun River were derived from daily counts obtained from a fence operated since 1984 (Linda Orman, DFO Prince Rupert, pers. comm.). Escapement timing for the other Canadian pink salmon stocks were derived from fisheries officer records of the mean start, peak and end dates for each stock group. In the absence of any annual information on escapement timing, we assumed that the run timing for these stocks were constant over all years.

### **Southern B.C. Sockeye Stocks**

In some years Southern Canadian sockeye stocks (essentially Fraser River sockeye) are thought to traverse the North Coast fisheries (Area 1 net, Area 1 troll south, Noyes and Dall -- see Tables 1 and 2). Since run size escaping from these fisheries is unknown, stock reconstruction was not feasible for the Southern Canadian sockeye stocks. However, the Pacific Salmon Commission (PSC) compiles weekly estimates of Fraser River sockeye stocks found in the North Coast fisheries based on scale discrimination analysis (PSC 1994, Gable and Cox-Rogers 1993). We obtained this data from Jim Gable, PSC, and have set the catch contribution of the "South" sockeye stock to the Fraser River sockeye estimates in this analysis. When multiple openings within a week occurred the estimated catch of Fraser River sockeye was prorated according to the total catch (all stocks) for each opening. Similarly, in 1982-88 the total District 104 catch of Fraser River sockeye was prorated between the Dall and Noyes fisheries according to the total catch for each fishery and week. Direct estimates of the catch of Fraser sockeye in the Dall and Noyes fisheries were available for 1989-95.



## **Alaskan Stocks**

The total annual escapement estimates for Alaskan sockeye stocks were obtained from ADF&G records (Ben Vanallen, ADF&G Juneau, pers. comm.). Estimates for the MacDonald and Hugh Smith sockeye stocks were derived from weir counts and escapements for other southern southeast Alaskan stocks were derived by extrapolating these annual weir counts using the fraction that these two lakes represented of the total estimated sockeye escapement in 1982 and 1983 (the two years of intensive sockeye studies in Districts 101-108). Unfortunately, the daily weir count data does not provide an accurate indication of escapement timing since sockeye tend to hold and accumulate below the weirs for extended periods of time. In some stream more than 50% of the total escapement may be counted past the weir in a single day. Consequently, estimates of escapement run timing for Alaskan sockeye stocks were derived from an analysis of scale pattern data for all southeast Alaskan fisheries. Weekly estimates of the contribution of Alaskan stocks were applied to the catch data for these fisheries and plotted to determine peak timing and duration of the run.

The annual escapement timings for each Alaskan pink salmon stock were derived from a systematic analysis of all the available Alaskan escapement survey data. The procedures used to analyze these survey data were similar the area-under-the-curve (AUC) methods used to estimate pink salmon escapement for numerous streams in Kodiak Alaska (Johnson and Barrett 1988; English et al. 1990). Appendix A provides a description of this AUC method. The results of the AUC analysis were used to convert the annual ADF&G index escapement for each District into daily index escapements. Initially, these index escapements were multiplied by 1.7 to convert the index values for 1982 into the total pink salmon escapement used to derive the tagging study interception estimates for 1982. Subsequently, a fixed expansion factor of 2.5 was used so the resulting escapement estimates would be consistent with those used by the Joint Interception Committee (JIC 1998).

## **Migration Routes**

A migration route is defined as the unique sequence of fisheries traversed by fish belonging to a particular stock. The existence of the routes was determined by: (1) discussions with DFO and ADF&G personnel, and (2) the release and recovery of marks during the North Coast Salmon Tagging Studies 1982-85 (Gazey et al. 1983, English et al. 1984, 1985a, Taylor et al. 1986). Setting the proportion of the stock size entering a fishery from alternative routes was the primary mechanism used to "fit" the reconstruction interception estimates to that obtained from the mark-recapture projects. Migration routing parameters and routing diagrams are provided for each sockeye and pink stock in appendices to this report.

## **Residency Time**

Residency time is defined as the number of days (to the nearest day) a fish resides within the boundaries of a single fishery. The travel time between boundaries of adjacent fisheries was assumed to be zero. Residency time estimates, obtained from English et al. 1985b, for sockeye and pink salmon are listed in Appendices B and F, respectively.

## **Stock Composition in Alaskan Areas from Scales**

Scale pattern analysis has been routinely conducted since 1982 to derive stock composition for sockeye catches in major Alaskan fisheries (Marshall et al. 1984). At most, six major stock groups have been used to partition the catch by week: (1) Southeast Alaska, (2) Nass River, (3) Skeena River, (4) Stikine River, (5) Tahltan River and (6) south coast stocks (assumed to be mostly the Fraser River). In many years and areas, the catch has been partitioned into only two stocks: 1) Alaska and 2) Nass and Skeena combined. In addition, the weekly stocks composition estimates are only available by major fisheries (defined by district and gear type). Separate estimates are available for most weeks for southern southeast Alaska's four district purse seine fisheries (District 101, 102, 103 and 104); and two major gillnet fisheries: District 101 (Cape Fox) and District 106 (Sumner and Upper Clarence Strait). Stock composition estimates are not available by sub-district area and, typically, scale data is limited for weeks at the start and end of the sockeye fishing season.

The use of the above stock composition estimates is optional for the northern boundary run reconstructions. If this option is selected, the stock composition estimates available for each Alaskan fishery are used at their defined level of resolution (stock group by week by fishery) and the equal vulnerability assumption is used for all fisheries without scale stock composition estimates and where the stock composition estimate do not separate Nass and Skeena stocks. In these latter cases, the stock composition data would be used to estimate the total catch of Nass and Skeena sockeye combined and the relative abundance of these two stocks would be used to estimate the catch for each stock in the relevant fisheries and week.

## **ANALYTICAL METHODS**

### **Reconstruction Algorithm**

The theoretical model base for the reconstruction of North Coast sockeye and Pink stocks follows Starr and Hilborn (1988), Gazey et al. (1989), Gazey (1992), and Cave and Gazey (1994). However, our model is unique in that: 1) the migration of fish into and out of fishing areas during a day is not allowed; 2) catch by major stock groups (scale stock composition estimate) are available in some areas and weeks; 3) variable catch accumulations (1 to 7 days) are employed; and 4) the migration of stocks in opposite directions is allowed. Furthermore, none of the above studies specify, comprehensively, the analytical procedures required for reconstruction. Therefore, we provide the algorithms in this document.

The algorithm can be made much more explicit by expressing it in step by step "pseudo-code" rather than with conventional equations. Therefore, we first express the classical stock reconstruction algorithm in mathematical explicit "p-code" so that refinements can be built upon the basic model.

Catch in Canadian waters can be resolved to a day through application of hail data. However, catch in US waters can only be resolved to a week. We assert that a daily time step is needed for the following two reasons:

1. The time step of the reconstruction must be sufficiently small to detail the immigration of fish into and the emigration of fish out of a fishery, during the course of that fishery. Indeed, since fish (particularly sockeye) can travel through some areas of interest (a fishery) in a single day, the use of time steps longer than a day will seriously distort harvest and movement dynamics.
2. Fisheries are managed by adding or removing days of fishing. The implications of such fishery adjustments can only be understood using a daily time-step. In other words, the impact of opening a fishery (i.e., the daily harvest rate) must be known if these fisheries are to be managed.

The refinements added to the basic reconstruction algorithm are those required to deal with stock specific catch data and catch data consisting of more than one day of fishing.

### Indices and Variables

The following indices are used:

- $f$  - fishery ( $f = 0_j$ )
- $g$  - stock group ( $g = 1, 2, \dots G$ )
- $j$  - fishery referenced in sequence ( $j = 1, 2, \dots J$ )
- $k$  - migration block of fish available to a fishery ( $k = 0, 1, 2, \dots r_{fs}$ )
- $m$  - time period greater or equal than a day
- $s$  - sub-stock (part of a stock with a unique migration route through the fisheries,  $s = 1, 2, \dots n$ )
- $t$  - time (day,  $t = 1, 2, \dots T$ )

in association with the following input variables:

- $C_{ft}$  - catch in fishery  $f$  during the  $t$ 'th day
- $C_{fm}$  - catch in fishery  $f$  during the  $m$ 'th interval
- $C_{ftg}$  - catch in fishery  $f$  during the  $t$ 'th day consisting of stock group  $g$
- $C_{fmg}$  - catch in fishery  $f$  during the  $m$ 'th interval consisting of stock group  $g$
- $E_{st}$  - escapement to sub-stock  $s$  during the  $t$ 'th day

- $I_{ft}$  - indicator variable (1 when fishery  $f$  open during day  $t$ ; otherwise, 0)  
 $I_{sg}$  - indicator variable (1 when substock  $s$  belongs to the  $g$ 'th stock group; otherwise, 0)  
 $O_j$  - fishery identifier or order as any stock migrates through the  $j$ 'th area  
 $p_{ftg}$  - catch proportion of stock group  $g$  taken in fishery  $f$  during the  $t$ 'th day  
 $r_{sf}$  - residence (days) of sub-stock  $s$  in fishery  $f$   
 $w_{sf}$  - travel time (days) from leaving a fishery  $f$  to escapement of sub-stock  $s$

and output variables:

- $h_{ft}$  - harvest rate of fishery  $f$  during the  $t$ 'th day  
 $h_{ftg}$  - harvest rate of fishery  $f$  during the  $t$ 'th day consisting of stock group  $g$   
 $N_{st}$  - available population (entering run size after reconstruction) of sub-stock  $s$  representing the run which would have escaped during the  $t$ 'th day

### Core Algorithm

The computational algorithm is given below in "pseudo-code", assuming that catch has a daily resolution:

1. Let  $N_{st} = E_{st}$  for all  $s$  and  $t$
2. Let  $t = T$
3. Let  $j = J$
4. Let  $f = O_j$
5. Solve  $C_{ft} = \frac{h_{ft}}{1-h_{ft}} \sum_{s=1}^n \sum_{k=0}^{r_{sf}-1} N_{s, t+w_{sf}+k}$  for  $h_{ft}$
6. Let  $N_{s, t+w_{fs}+k} = \frac{N_{s, t+w_{fs}+k}}{1-h_{ft}}$  for  $s = 1, 2, \dots, n$  and  $k = 0, 1, 2, \dots, r_{sf}-1$
7. Let  $j = j - 1$
8. if  $j \neq 0$  then go to step (4)
9. Let  $t = t - 1$
10. If  $t = 0$  then finished; otherwise, go to step (3).

Step (1) of the algorithm copies the daily escapement for a specific stock into a vector which will be expanded in subsequent steps to represent the entering run size. Step (2) initiates the time (day) counter to the last day in the season. The iterative part of the algorithm starts in step (3) which sets the fishery reference to the last fishery through which fish pass prior to escapement. Step (4) identifies the current fishery. Step (5) solves the catch equation for the harvest rate and the run size is expanded by the survival rate in step (6). Note that in steps (5) and (6) the residence does not exist ( $r_{sf} = 0$ ) if the sub-stock never passes through the fishery and thus the sub-stock is not referenced. The fishery index is decreased (the next fishery to be processed) in step (7) and tested in step (8) to see if all the fisheries have been processed. Finally, step (9) decreases the time counter by one day and step (10) tests if there are any more days to process.

The above structure is said to be "rigid" because variable movement speeds are not accommodated (e.g., fish in the latter part of a season may move at a faster speed). While we do not anticipate the need for variable movement speeds, the existing algorithm need only be changed by making  $r_{sf}$  (residence time in a fishery) and  $w_{sf}$  (travel time to escapement) a function of time.

Further note that we specified the order ( $O_j$ ) that fisheries were to be processed in the basic algorithm. However, since a daily migration block of a sub-stock can only be in one fishery in any one day, the fishery order is inconsequential in the basic reconstruction algorithm.

### Reconstruction Algorithm for Catch by Stock Group

Stock groups in the reconstruction model are defined as follows: 1) equal vulnerability (all stocks), 2) Southeast Alaska, 3) Nass River, 4) Skeena River, 5) Nass or Skeena rivers, and 6) Stikine or Tahltan rivers. By definition, the stock group proportions must sum to one for a fishery and day, i.e.,

$$\sum_{g=1}^G P_{ftg} = 1$$

If the catch is not defined by the scale composition data (groups 2-6) for a given fishery and day then the default, group 1 (all stocks potentially available), is assigned. Note that stock group 1 proportion can only take on a value of zero or one in a given fishery and day. Also, if group 5 has a positive value then groups 3 and 4 must be both zero.

The computational algorithm is similar to the core algorithm but has been expanded to account for the stock groups as follows:

1. Let  $N_{st} = E_{st}$  for all  $s$  and  $t$
2. Let  $t = T$
3. Let  $j = J$
4. Let  $f = O_j$
5. Let  $g = 0$
6. Let  $g = g + 1$
7. Let  $C_{ftg} = C_{ft} P_{ftg}$
8. Solve  $C_{ftg} = \frac{h_{ftg}}{1 - h_{ftg}} \sum_{s=1}^n I_{sg} \sum_{k=0}^{r_{sg}-1} N_{s, t+w_{fs}+k}$  for  $h_{ftg}$
9. Let  $N_{s, t+w_{fs}+k} = \frac{N_{s, t+w_{fs}+k}}{1 - h_{ftg}}$  for  $I_{sg} \neq 0$  and  $k = 0, 1, 2, \dots, r_{sg} - 1$
10. If  $g \neq G$  then go to step 6
11. Let  $j = j - 1$
12. if  $j \neq 0$  then go to step (4)
13. Let  $t = t - 1$
14. If  $t = 0$  then finished; otherwise, go to step (3).

Steps (1) to (4) are identical to the core algorithm. Step (5) initiates the stock group index to 0. The iterative loop over the stock groups begins with increment of the group index in step (6). Step (7) calculates the catch for the current stock group. Step (8) solves the catch equation for the stock group harvest rate and the run size is expanded by the stock group survival rate in step (9). The stock group index is tested in step (10) to see if all stock groups have been processed. Steps (11)-(14) are identical to steps (7)-(10) in the core algorithm. Note that if only the first stock group is used (i.e., equal vulnerability) then the above algorithm collapses to the core algorithm. Therefore, all future references to the "reconstruction algorithm" imply catch by stock group.

### Reconstruction Algorithm For Variable Catch Accumulations

Starr and Hilborn (1988) recommend pooling time periods to overcome problems in miss-allocation of catch by time period and further state that a daily time step should be

avoided because of this type of error. However, instead of slicing both catch and escapement into uniform daily intervals, reconstruction can proceed with catch accumulated over any time period,  $m$ , (e.g., week, month) while escapement is maintained at a daily resolution under the assumption that the harvest rate is constant over the time interval  $m$ . Thus we can substitute step (8) with:

$$\text{solve } C_{fmg} = \sum_{t < m} C_{ftg} = \sum_{t < m} \frac{I_{ft} h_{ftg}}{\prod (1 - h_{ftg})} \sum_{s=1}^n I_{sg} \sum_{k=0}^{r_{sf}-1} N_{s, t+w_{sf}+k} \text{ for } h_{ftg}$$

where all variables are defined as above except for  $I_{ft}$  which is an indicator variable for an opening of fishery  $f$  during day  $t$ . The only unknown is  $h_{ftg}$  (assumed to be constant over the period  $m$ ) and a numerical solution can be found easily with the bisection method since  $h$  must be real and bounded by 0 and 1.

Since the daily migration blocks expanded for the catch taken over the period  $m$  can be in more than one fishery over the period  $m$ , the reconstruction now requires a migration sequence of fisheries common to all sub-stocks (i.e., a gauntlet common to all sub-stocks). Thus, the fishery order used in reconstruction ( $O_j$ ) is no longer inconsequential. Violation of this condition requires first that sub-stocks travel in opposite directions between fisheries and, second, that the catch taken in the interval  $m$  be from fish susceptible to capture in at least two of the fisheries in conflict. In theory, a set of simultaneous equations could be developed and solved for conflict situations; however, in practice, dealing with many fisheries will become very cumbersome. Fortunately, for our situation, the simultaneous solution of 2 fisheries along with judicious ordering of the fisheries solves all significant conflicts for migration routes considered to date.

### Bisection Algorithm for One Fishery

Let the calculated catch over the period  $m$  (e.g., a week) be defined as function  $g(h)$ , i.e.,

$$g(h_{ftg}) = \sum_{t < m} \frac{I_{ft} h_{ftg}}{\prod (1 - h_{ftg})} \sum_{s=1}^n I_{sg} \sum_{k=0}^{r_{sf}-1} N_{s, t+w_{sf}+k}$$

For clarity we have dropped the subscripts and refer to the weekly catch as  $C$  and the constant daily harvest rate over the period  $m$  as  $h$ . The algorithm is as follows:

1. Let  $low = 0$
2. Let  $high = 1$
3. Let  $h = 0.5$
4. Let  $tol = 0.001$

5. Let  $test = \frac{|C-g(h)|}{C} 100$
6. If  $test < tol$  then finished
7. If  $C > g(h)$  then let  $low = h$  else let  $high = h$
8. Let  $h = \frac{low+high}{2}$
9. Go to step (5)

Steps (1) and (2) initialize the low and high feasible values for the harvest rate to 0 and 1, respectively. Step (3) sets the initial harvest rate estimate to 0.5 and step (4) sets the tolerance for convergence to a thousandths of a percent. The iterative part of the algorithm begins with step (5) where the percent relative catch error is calculated using the current harvest rate estimate. The calculations finish at step (6) if the relative error is less than the tolerance of a thousandths of a percent. The feasible bounds are adjusted in step (7) under the logic that if the true catch is greater than the computed catch then the harvest rate must be greater than the current estimate and vice-versa. The new harvest rate estimate for the next iteration is computed as the mid-point between the feasible bounds in step (8).

### Bisection Algorithm for Two Fisheries

If stocks are travelling in opposite directions between two fisheries then the harvest rates are solved by the simultaneous solution of the catch functions.

Let the calculated catches over the period  $m$  (e.g., a week) be defined as catch functions  $g_1(h_1, h_2)$  and  $g_2(h_2, h_1)$ , i.e.,

$$g_1(h_{1tg}, h_{2tg}) = \sum_{tcm} \frac{I_{1t} h_{1tg}}{\prod_{tcm} (1-h_{1tg}) (1-I_{2t} h_{2tg})} \sum_{s=1}^n I_{sg} \sum_{k=0}^{r_{sg}-1} N_{s, t+w_{sg}+k}$$

For clarity, we have dropped the subscripts and refer to the weekly catch as  $C_1$  and  $C_2$ , and the constant daily harvest rates over the period  $m$  as  $h_1$  and  $h_2$  in the two fisheries. The algorithm is as follows:

1. Let  $low_1 = low_2 = 0$
2. Let  $high_1 = high_2 = 1$
3. Let  $h_1 = h_2 = 0.5$
4. Let  $tol = 0.001$
5. Let  $test_1 = \frac{|C_1 - g_1(h_1, h_2)|}{C_1} 100$
6. Let  $test_2 = \frac{|C_2 - g_2(h_2, h_1)|}{C_2} 100$
7. If  $test_1 < tol$  and  $test_2 < tol$  then finished



8. Let  $tlow = low_2$
9. Let  $thigh = high_2$
10. If  $[g_1(h_1, h_2) \leq C_1 \text{ or } g_2(h_2, h_1) \leq C_2]$  and  $[g_1(h_1, h_2) \geq C_1 \text{ or } g_2(h_2, h_1) \geq C_2]$  then go to step 14
11. If  $g_1(h_1, h_2) > C_1$  then let  $thigh = h_2$  else let  $tlow = h_2$
12. Let  $h_2 = \frac{tlow + thigh}{2}$
13. Go to step (10)
14. If  $g_1(h_1, h_2) \leq C_1$  then go to step 18
15. Let  $high_1 = h_1$
16. Let  $low_2 = h_2$
17. Go to step (20)
18. Let  $low_1 = h_1$
19. Let  $high_2 = h_2$
20. Let  $h_1 = \frac{low_1 + high_1}{2}$
21. Let  $h_2 = \frac{low_2 + high_2}{2}$
22. Go to step (5)

Similar to the one fishery algorithm steps (1) to (4) set the initial low and high feasible harvest rates and the tolerance for convergence. The iterative part of the algorithm again starts at step (5). Steps (5) and (6) calculate the relative percent error for the actual versus computed catch and the convergence test is conducted by step (7). Steps (8) and (9) initialize temporary variables to the current feasible bounds for fishery 2. The fulcrum control of the algorithm is specified in step (10). The idea is that if the computed catch is too large in one fishery while in the other fishery the computed catch is too small, then the adjustment directions for the harvest rates are known (altering the catch in one fishery has either no effect or an inverse effect in the other fishery) and we can proceed in a straight forward fashion starting at step (14). If this is not the case (i.e., the computed catch is either too low or too high in both fisheries) then we search (steps 10 to 13) for a harvest rate in fishery 2 which produces the desired result (i.e., estimated catches straddle the true values). Steps (14) to (19) adjust the bounds in the appropriate directions and the new harvest rate mid-point estimates are computed in steps (20) and (21).

### Migration Route Specification

The reconstruction of the North Coast complex of stocks requires the definition of alternative migration routes through the fisheries. Central to the algorithm to determine these routes and the proportion of the stock which takes any unique route (termed a sub-stock) is the specification of the percent coming into an area from alternative fisheries. For example, we may hypothesize that Skeena sockeye stock enters statistical area 3y either from Cape Fox or area 3x and specify the percent composition (e.g., 10% from 3x and 90% from Cape Fox). By

starting at the stock origin and working sequentially backwards (with reference to the movement of fish) through the alternative routes, the full set of migration routes can be easily defined. This backwards-moving procedure is an elementary illustration of a technique coined dynamic programming.

### Parameterization of Migration Routes with Mark-Recapture Data

The application of mark-recapture data to parameterize migration routes suffers from the problem that the mark could have traversed several fisheries prior to recapture. Under the assumption that fish move from fishery  $i$  to fishery  $j$  then the quantity we want is:

$p_{ij}^*$  = proportion of fish (tags) moving into fishery of interest ( $j$ ) from  $i$ . Note that:

$$\sum_i p_{ij}^* = 1$$

and by definition:

$$p_{ij}^* = \frac{P_{ij}}{\sum_{i \neq j} P_{ij}}$$

where,  $p_{ij}$  is the proportion released in  $i$  and recaptured in  $j$  which take the  $i$ - $j$  route. Further note that the definition is tied to the release and recapture of salmon where the stock origin is usually unknown. Thus, the estimated proportions are not stock specific. In other words,  $p_{ij}$  applies to all stocks moving from fishery  $i$  to fishery  $j$ .

- If tags released in fishery  $i$  can only travel directly to fishery  $j$  with no intervening fisheries then the estimate of  $p_{ij}$  is simply the ratio of recaptures to releases, i.e.,

$$p_{ij} = \frac{r_{ij}}{R_i} \tag{1}$$

where,  $r_{ij}$  represents total tag recoveries (expanded for sampling) in fishery  $j$  released in fishery  $i$  and  $R_i$  is the number of releases made in fishery  $i$ . Since all tags are moving to a common fishery ( $j$ ), the expansion of recoveries for sampling intensity is not mandatory.

When there is an intervening fishery the situation becomes more complicated. For example, if we were interested in the proportion moving into fishery 3 from fisheries 1 and 2, yet fish could move from fishery 1 to 2 to 3 as well as from 1 to 3 directly, then recoveries of tags in 3 can not be assigned to their respective migration routes directly. Our approach for this simple triangle of fisheries has been sufficient for all migration routes considered to date;

however, if needed, the same method could be generalized to a more complicated set of fisheries.

We form an estimate in this simple 3 fishery system by focusing upon the proportion released in 1 and recaptured in 3 which take the direct 1-3 route ( $p_{13}$ ) with the following logic:

(1) By definition, the proportion of fish taking the 1-2 route versus the 1-3 route is described by

$$\frac{p_{12}}{p_{12} + p_{13}}$$

(2) Therefore, the potential number of tags from 1 which travel to 2 and are not removed are as follows:

$$\left( \frac{p_{12}}{p_{12} + p_{13}} \right) R_1 - r_{12}$$

(3) Under the assumption the potential number of tags (above) are eventually recaptured in 3 at the same rate as tags released in 2, an estimate of the number of recaptures which took the direct 1-3 route can be made by subtraction, i.e.,

$$R_1 p_{13} = r_{13} - \left[ \left( \frac{p_{12}}{p_{12} + p_{13}} \right) R_1 - r_{12} \right] p_{23} \quad (2)$$

Equation (2) can be rearranged into a quadratic form with constants  $f$ ,  $g$  and  $h$ , i.e.,

$$f p_{13}^2 + g p_{13} + h = 0$$

where,

$$\begin{aligned} f &= R_1 \\ g &= r_{12}(1 - p_{23}) - r_{13} \\ h &= p_{12}[p_{23}(R_1 - r_{12}) - r_{13}] \end{aligned}$$

Note that the constants  $f$ ,  $g$  and  $h$  are known from the data because  $p_{12}$  and  $p_{23}$  can be replaced with the simple relationship given by equation (1). Therefore, solving for  $p_{13}$  yields:

$$p_{13} = \frac{-g \pm \sqrt{g^2 - 4fh}}{2f}$$

If the above solutions are real then the solution between 0 and 1 should be used. If the solutions are complex then either random variability in the recoveries or an assumption violation (e.g., stock specific movement and/or recapture rates dependent upon release site) has produced a problem. An approximation can be made by setting  $h$  to zero which is equivalent to imposing the restriction that recoveries in fishery 3 are always directly proportional to the releases available for recapture, i.e.,

$$\frac{R_1 - r_{12}}{R_2} = \frac{r_{13}}{r_{23}}$$

Because more losses might be expected on the longer route (1 to 2 to 3) than on the shorter (1 to 3), the approximation likely over-corrects for the more circuitous route.

Parameter estimates for all alternative routes into a common fishery were made following the above methodology for each species. Given the network of migration routes generated from these parameters, the fraction of the stock on each unique route and percentage of the stock passing through each of the fisheries can be calculated.

### Reconstruction of Sockeye Salmon

The primary objective of the sockeye salmon reconstruction exercise was to fit (minimize the absolute difference) the 1982 and 1983 interception estimates derived from the North Coast Tagging Project through changing only the migration route proportion. Catch, escapement counts and timing, possible migration routes and migration speed were considered fixed. Since interception estimates obtained from mark recapture data better approximate stock proportions available to a fishery (coined "stock interception") than the stock composition of the catch (coined "catch interception" -- Gazey 1983), the stock interception estimates from the reconstruction were used for the comparisons. The migration proportions were initially set to the values estimated directly with the mark-recapture data. Next, the migration proportions were altered iteratively for each fishery to fit the 1982 and 1983 tag interception estimates. The fisheries were sequenced by working backwards through the migration sequence defined for the Skeena River stock (see Appendix B). This process was repeated using the migration sequence of fisheries defined for the other stocks (Nass, US MacDonald, and US other) to arrive at a single sequence for the analysis of fisheries that would be appropriate to reconstruct runs for all stocks.

The migration proportions estimated for 1982 and 1983 were then used to reconstruct 1984 to 1995. The stock composition of the catch was then compared to the results of racial scale analysis provided by ADF&G and the best set of migration proportions (1982 or 1983) was selected based on the sum of squares.

Finally, the Canadian balance (with respect to U.S. catch of B.C. stocks) of sockeye salmon was calculated from the run reconstruction results and compared to the balance given by the Canada/U.S. Joint Interception Committee (JIC 1993).

### **Reconstruction of Pink Salmon**

The initial approach to pink salmon run reconstructions was similar to that for sockeye. Migration routes and proportions were defined based on the 1982 northern boundary tagging study data (English et al. 1995b). The 1982 interception rates derived from run reconstructions based on these parameters were compared with the tagging study results and the differences between the estimates were examined. Migration route and proportions were adjusted such that the interception rates for Alaskan stocks in each fishery approximated those estimated from the 1982 tagging study data (Gazey et al. 1983, Pella et al. 1993). The estimates from both reports had to be combined because Gazey et al. (1983) was the only source for detailed stock specific interception rates for each fishery; however, for the purpose of this analysis the Northern Boundary Technical Committee agreed that Pella et al. (1993) provided the best estimate of the total contribution of Alaskan stocks to each fishery.

Once satisfied with the 1982 run reconstruction, the 1984 and 1985 pink salmon runs were reconstructed using the same migration route parameters. The resulting interception estimates were compared with the estimates from the 1984 and 1985 tagging studies (English et al. 1985a, Taylor et al. 1986, Pella et al. 1993).

### **Sensitivity**

The sensitivity of reconstruction results (the catch allocated to a stock) to invalid model assumptions and data errors is an important issue for an evaluation of the technique. The four major model assumptions are (1) a rigid "box car" structure (all fish of a particular migration route day-block move together through the fisheries and the migration speed does not change over the season), (2) equal catch vulnerability of all stocks within a fishery, (3) constant migration route proportions over a season, and (4) equal fishing power for successive days if more than a one day opening. We are unaware of any information which can invalidate these model assumptions in the marine fisheries portrayed; however, we must also acknowledge that to the best of our knowledge none these assumptions (hypotheses) have been directly tested nor can they be rigorously tested with currently available data. The consensus of DFO and ADF&G personnel was that these assumptions at least approximate the biological and harvest system.

There are seven parameter or data errors that can effect the reconstruction analysis: (1) catch counts, (2) catch timing (i.e., allocated to the correct opening), (3) escapement counts, (4) escapement timing, (5) migration route existence, (6) migration route proportions and (7) residency time. Again, little objective information is available on the precision and accuracy of the input data. The catch count, catch timing, escapement timing, migration route existence

and residency time are generally believed (by DFO and ADF&G personnel) to have little error or to be known. On the other hand, larger error (greater uncertainty) is generally associated with the escapement counts and the migration route proportions.

Starr and Hilborn (1988) recommend the application of Monte Carlo simulation methods to characterize confidence in specific outputs (run size, harvest rates, interception rates) given the uncertainties in the inputs. Accordingly, we have constructed a Monte Carlo reconstruction model that assumes a normal distribution for the escapement counts and migration route proportions.

We performed 1000 Monte Carlo trials on the 1983 sockeye reconstruction with a coefficient of variation of 0.3 for total escapement count and the migration route proportions. The distribution of escapement remained constant for all simulations. Migration route proportions were held constant within each iteration, but they varied between iterations.

Because of large differences in meteorological characteristics and migration patterns for 1982 and 1983 (Blackbourn 1987), reconstructions for these years provided a practical envelope for the variation in interception estimates from these alternative migration proportions. The range of variation in sockeye interception estimates was generated by using the 1982 fitted proportions to reconstruct the 1983 data and the 1983 fitted proportions to reconstruct the 1982 data.

## RESULTS

### Sockeye

The relative size and importance of each sockeye fishery and stock is best summarized by the catch and escapement estimate which drive the run reconstruction analysis (Table 4). Sockeye catch is distributed over 21 of the fisheries with the major fisheries (Area 3, Area 4, Noyes, and Dall) representing over 78% of the harvest. A summary of the migration route proportions Skeena and Nass sockeye stocks, calculated from recovery of tags in 1982 and 1983, are given in Table 5. In many cases, the estimated migration route proportions derived from the tagging study data were substantially different from those generated by the stock compositions that fit the 1982 and 1983 interception rates. These results are not surprising given the difficulties associated with estimating migration routing parameters from conventional mark-recapture data. The fit of the stock interception rates, obtained by altering the migration proportions for the 1982 and 1983 reconstructions, was the same regardless of the sequence of fisheries used.

The sockeye migration routes defined for 1982 and 1983 produced stock specific interception rates that were within 3 percentage points of the tagging study estimates for each fishery-stock combination (Table 6). The input files defining these migration routes and proportions are provided in Appendix B, and are plotted in Appendix C. In the absence of

fishing, these migration routes and proportions can be used to calculate the percentage of the stock that passes through each fishery (Tables 7). These percentage reveals that the migration proportions required to fit the tagging study stock composition estimates are substantially different for the two years. For example: the portion of the US sockeye stocks migrating through Canadian fisheries had to be set much higher in 1982 than 1983 to fit the tagging study estimates. Conversely, the portion of the Canadian stocks migrating through Alaskan fisheries was set lower in 1982 than 1983.

The reconstruction analyses for the 1984-95 data revealed that the 1983 migration route proportion set was markedly better at mimicking the racial catch composition from scale analysis. Therefore, the 1983 pattern was used for all subsequent analyses. Detailed estimates of the sockeye catch by stock and fishery for each year and run reconstruction approach are provided in Appendix D and summarized in Table 8. The differences between the estimates derived assuming equal vulnerability and those derived using the available scale stock composition estimates for Alaskan fisheries are provided in Appendix E and summarized in Table 9. In most instances, the differences between the stock size estimates from the two run reconstruction approaches were small compared to the range in stock sizes observed from 1982-95 (Fig. 2). However, estimates of the size of US sockeye stocks based on equal vulnerability are consistently smaller (2-30%) than the stock size estimates based on the available scale data (Table 9). The largest differences between US stock size estimates for the two reconstruction approaches occurred in years with the lowest escapement estimates for Alaskan sockeye stocks (1982, 83, 88, 95). Higher Alaskan escapements or revised migration routings would be required to eliminate the difference between the annual US stock size estimates derived from the two reconstruction approaches. It should be noted that the migration parameters used for all years after 1982 were derived by fitting the 1983 tagging study interception estimates. Since the tagging study results suggested a high interception of BC sockeye in Alaskan fisheries than the scale data, the reflection of these differences in other years is not surprising.

Estimates of the size of the Nass sockeye stock, assuming equal vulnerability, were generally smaller (12-25%) than those based on the scale data in years when the Nass stock was small (1986-88,90) and larger (3-13%) in years when the Nass stock was large (1992-95). Since the escapement estimates for Nass sockeye are reliable these results suggest that either the vulnerability of Nass sockeye inversely related to abundance, or the northern boundary scale data tends to overestimate the contribution when the stock size is small and underestimate the contribution when the stock size is large. The later explanation is consistent with observations from other regions where scale data has been used to determining the stock composition for sockeye fisheries (PSC 1995).

Reconstructions based on scale data indicate that, on average, Alaskan sockeye salmon stocks represent 16% of the total annual production in the northern boundary area. Skeena sockeye represent the largest portion of regions production at 64%, followed by Nass and US Other at 17% and 11%, respectively. Mean annual harvest rates for Skeena, Nass and US

MacDonald range from 41 to 60%. The harvest rate estimates for Stikine stocks (mean 27%) were consistently lower than those estimated for the other Canadian stocks and the annual harvest rates for US Other (mean 32%) were generally lower than those for the Skeena, Nass and US MacDonald stocks.

Table 10 summarizes the annual interception estimates for Alaskan sockeye salmon in northern boundary fisheries. This summary indicates that, aside from 1982, the contribution of Alaskan stocks to Canadian net fisheries has been consistently small (0-7%). Contributions of Alaskan stocks to Alaskan fisheries have been considerably more variable: 10-40% for the Noyes and Dall Island fisheries; 32-88% in the Sumner Straits fishery; 31-76% in Lower Clarence; and 8-39% at Cape Fox (Tree Point).

The Canadian balance for northern boundary fisheries (BC sockeye harvested in Alaskan fisheries minus Alaskan sockeye harvested in BC fisheries) derived from the reconstruction analyses is given in Table 11. On average, Alaskan sockeye represent only 1% of the sockeye harvested in Canadian fisheries while Canadian sockeye represent 65-73% of the sockeye harvested in Alaskan fisheries. This results in annual interception imbalances of 262,000-1,423,000 and a mean annual imbalance of 793,000 total for run reconstructions assuming equal vulnerability. The estimated imbalances were similar but slightly lower from run reconstructions using the stock composition estimates from Alaska scale data.

Comparison of the interception balance estimated using the equal vulnerability approach with the values produced by the Joint Interception Committee (JIC in prep.) reveals annual differences of 1,000-135,000 (Table 12) and an overall difference of 327,000 sockeye (5% of the total Canadian balance for 1982-95). Comparison of these estimates with those derived using the Alaskan scale data show annual differences of 1,000-114,000 and an overall difference of -447,000 (-8% of the total Canadian balance). In most years, the JIC estimates suggest that Alaskan interceptions of Canadian stocks are smaller than those derived from reconstructions assuming equal vulnerability but larger than the reconstruction results computed using the available scale data (Fig. 3). The JIC estimates for 1982-95 were derived using the available scale data for Alaskan fisheries and interception rates from the 1982-83 international tagging studies for Canadian fisheries. The largest percentage differences observed between the JIC and run reconstruction estimate occurred from 1982-84 which reflects the differences previously observed between the interception rates derived from the 1982-83 adult sockeye tagging studies and those derived from scale samples. Aside from these early differences, the JIC estimates are very close to those derived from reconstructions using Alaskan scale data (Fig. 3).

## **Pink**

The relative size and importance of each pink salmon fishery and stock can be readily assessed by examining a summary of the catch and escapement estimate used in our run reconstruction analyses (Table 13 and 14). Pink salmon catch is distributed over all 25 of the



northern boundary fisheries with the major fisheries (Noyes, Dall, Lower Clarence, Revilla and Area 3y+7) representing over 74% of the harvest. A summary of the migration route proportions for Skeena and US101 pink salmon stocks, calculated from recovery of tags in 1982, 1984 and 1985, are given in Table 15. In contrast to sockeye, the estimates derived from the 1982 pink salmon tagging study data are similar to the routing parameters which generate stock compositions that fit the 1982, 1984 and 1985 interception rates. These results were surprising given the observed variability in interception rate but supported by the similarities observed in migration proportions between tagging study years.

The pink salmon migration routes defined for 1982 produced interception rates for the all US stocks that were always within 15 percentage points of the tagging study estimates for each fishery (Table 16). In the vast majority of comparisons, the differences between tagging study and run reconstruction estimates for interceptions of Alaskan stocks were less than 7 percentage points. In only 7 of 38 comparisons were the run reconstruction estimates of contribution of Alaskan stocks more than 10 percentage points different from the tagging study estimates. Most of these large differences were associated with 1985, where tagging study results suggest the contribution of Alaskan stocks to inside Area 3 fisheries was relatively high in 1985 while contributions of Alaskan stocks to outside Area 3 and Area 4 fisheries was much lower in 1985 than in 1982 and 1984. These inconsistencies and other data limitation suggest that the tagging study estimates may not be accurate for these fisheries in 1985.

Given the large number of fishery-year comparisons we found it useful to summarize these comparisons using Table 17, which provides a direct comparison of the total interception rate for all Alaskan pink salmon stocks by fishery along with detailed information on the percent difference between the tagging study and run reconstruction results for each stock. Despite the substantial changes in the interception rates for Alaskan stocks in several Canadian fisheries, a single set of migration parameters reasonably approximated the 1982-85 tagging study results. Closer examination of the detailed stock composition comparison in Table 17 reveals a few fisheries where further refinements could be made to the routing parameters for pink salmon which would make the run reconstruction results more consistent with the tagging study estimates. For example, according to the tagging study data a smaller portion of the US103 stock should be routed through the Area 1 (Langara) net fishery and the portion of the US102 stock migrating through the outside Area 3 fisheries should be reduced by roughly 50%. However, both of these changes are no more than fine tuning because these stocks represent less than 7% of the total harvest in these fisheries.

The input file defining the pink salmon migration routes and proportions is provided in Appendix F and the values are plotted in Appendix G. The percentage of each stock that would pass through each of the fisheries, in the absence of fishing, is provided in Table 18. In general, each stock has one or more terminal fisheries through which 80-100% of the stock passes. Outside these fisheries the portion for any specific stock migrating through a fishery is usually less than 50% of the stock.

The detailed run reconstruction results for pink salmon are provided in Appendix H. Table 19 summarizes the annual estimates of total returns and harvest rates by stock. On average, Alaskan pink salmon stocks represent 84% of the total annual production in the northern boundary area. District 101 streams represent the largest portion of regions production at 36%, followed by District 103/4, District 102 and Skeena River stocks at 20%, 13% and 12%, respectively. Mean annual harvest rates for District 101, 102, Skeena and Area 3 inside stocks are all similar at 62-68%. The mean harvest rate estimate of 29% for the District 103/4 stock is the lowest of the Alaskan stocks while mean annual harvest rates for the minor Canadian stocks range from 14-31%. We have excluded the run reconstruction results for Fraser pink salmon (south) from Table 19 because only 25% of this stock were assumed to migrate through fisheries in the outer portion of the northern boundary area. Estimates of the contribution of Fraser pink salmon stocks to northern boundary fisheries are provided in Appendix H.

Table 20 summarizes the annual interception estimates for Alaskan pink salmon in northern boundary fisheries. This summary clearly indicates that the contribution of Alaskan stocks to Canadian fisheries can vary substantially from year to year: 19-84% at Langara; 15-93% in the northern Area 1 troll fishery; 20-65% in Area 3x; 26-81% in Area 3y+7; 17-59% in Area 3z-7; 18-56% in the outer portion of Area 4; and 9-53% in Area 5. Since these results were derived from a fixed migration routing, the variability in the contribution of Alaskan stocks to Canadian fisheries is the result of year to year difference in: 1) the spatial and temporal distribution of harvests; 2) the relative size of Canadian and Alaskan escapement; and 3) stock specific run timing. Year to year variability in the contribution of Alaskan stocks to Alaskan fisheries tends to be less than that observed in Canadian fisheries because Alaskan stocks generally represent more than 80% of the Alaskan harvest.

The Canadian balance for northern boundary pink salmon fisheries (BC stocks harvested in Alaskan fisheries minus Alaskan stocks harvested in BC fisheries) derived from the reconstruction analyses is given in Table 21. On average, Alaskan stocks represent 41% of the pink salmon harvested in Canadian fisheries while Canadian stocks represent only 9% of the pink salmon harvested in Alaskan fisheries. This results in annual interception imbalances of 165,000-6,334,000 and a mean annual imbalance of 12,000.

Run reconstruction and Joint Interception Committee (JIC) estimates of Canadian harvests of Alaskan pink stocks and Alaskan harvests of Canadian pink stocks were generally similar for 1982 through 1989 (Table 21, Fig. 4). However, the run reconstruction estimates for 1986, 1990 and 1992 indicate that Canadian interception balance for pink salmon was less than that estimated by JIC (1998) and in 1991 Canadian interception balance was substantially larger than that estimated by JIC. In 1986, 1990 and 1992 escapement to Alaskan stocks represented 81-91% of total escapement for stocks migrating through northern boundary fisheries compared to only 61% in 1991. The apparent anomalous results for 1991 are the direct result of a record return to the Skeena along with large returns to inside Area 3 and the Fraser River while the major Alaskan stock (District 101) recorded less than average returns.

## Sensitivity

An example of the range of estimates produced by the Monte Carlo simulation of the 1983 sockeye reconstruction is provided for the Nass stock and two sample fisheries (Fig. 2). Similar results could be expected for other stocks and fisheries because we have used a symmetric normal distribution with variance proportional to the means (i.e., a constant coefficient of variation) for the error structure of input variables. The following generalizations can be made: 1) the distributions for the interception rates are fairly tight (interception estimates are said to be insensitive) while the run size distribution is much broader; and 2) since the interception estimates have a marginal multinomial distribution by definition, the variance is proportional to  $p(1-p)$  where  $p$  is the interception rate. Thus, the largest uncertainty will occur when interception rates are near 50%, and the distribution of interception rates shown in Fig. 2 will be skewed right when the rate is less than 50% and skewed left when the rate is greater than 50%.

The change in the catch interception rates from the use of inappropriate migration routing (1982 and 1983 reversed) is displayed in Table 22. Some of the changes are large (up to 35%) indicating that accurate specification of the routing is important.

## DISCUSSION

We propose that the run reconstruction methods outlined in this report be a component of the annual assessments for northern boundary sockeye and pink salmon fisheries. The methods outlined in this report can provide fisheries managers with consistent and objective estimates of run size, run timing and fisheries specific stock compositions using all the available catch and escapement data. Each year's run reconstruction results should be reviewed by Canadian and Alaskan fisheries managers and alternative assumptions tested as a routine component of the post-season stock assessment process. This process will help build the understanding and information base required to monitor trends in stock productivity and evaluate alternative fisheries management plans.

The information required for a rigorous run reconstruction analysis forces the managers and stock assessment biologist to test their understanding and assumptions regarding the stocks and fisheries in question. Existing databases seldom have data of sufficient spatial and temporal resolution for the analysis for daily fishing dynamics on rapidly moving stocks. The types of analysis required to convert the available catch and escapement data into a form suitable for daily run reconstructions provide a rapid insight into the strengths and weakness of the fundamental information required to manage salmon fisheries. In the above analysis, this process led to the redefinition of fisheries, the identification and correction of errors in Canadian hail and sale slip databases, the reanalysis of escapement estimates for major Canadian and Alaskan stocks and the identification of stocks specific migration routes. The integration of independent stock composition data into the run reconstructions for sockeye has made it much easier to compare results from the two reconstruction approaches. These analyses and comparisons have helped us identify deficiencies in the initial reconstruction results and make the necessary corrections. While most of the critical analyses and corrections have been completed, it is important to note that these are ongoing tasks that are an integral part of the run reconstruction process and results will change as the process and understanding evolves.

Our results for sockeye show a very high degree of agreement between the run reconstructions based equal vulnerability and those derived using the Alaskan scale data (Fig. 2). This should not be too surprising given that more than 80% of the sockeye are Canadian stocks and the majority of the return of these stocks is either escapement or Canadian catch which is identical between the two reconstruction approaches. What is more surprising is the consistent difference between the two model estimates of the annual size of the Alaskan sockeye stock. These differences also reflect the 1982 and 1983 observations that scale stock composition data shows a higher contribution of Alaskan stocks to Alaskan fisheries than those derived from the International Salmon Tagging Program (Gazey et al. 1983; English et al. 1994).

Despite the substantial year to year variability in the interception of Alaskan pink salmon in some Canadian fisheries, our reconstructions indicated that it was possible to approximate the 1982-85 International Salmon Tagging Program results for each study year using a single set of migration parameters. Substantial changes in the annual abundance of major pink salmon stocks appears to explain most of the variability observed in the tagging study interception rates. Comparison of the Canadian interception balance computed from the run reconstructions with estimates produced by the Joint Interception Committee revealed some substantial differences for pink salmon (e.g., 1986, 1990, 1991). These differences can not be attributed to the overall escapement estimates since both methods used the same total escapement estimates. However, the current JIC method does not take into account the relative abundance of each Alaskan pink salmon stock and the sequence of fishery harvests. This was particularly important in years like 1991 when Canadian catches and escapements for Area 3 and 4 were larger than those for the usually dominant inside Alaskan stocks (District 101-102), and harvest in Alaskan outside fisheries (Noyes and Dall) were at record levels. These and other observations suggest that further examination of Alaskan escapement estimates and JIC procedures for pink salmon is required.

The Monte Carlo simulation applied in this study served to illustrate that the current run reconstruction model can be used to assess the impact of errors in the input variables if their structure were known. However, more information on the accuracy and precision of the input data is required before further sensitivity analyses can provide a better understanding of the uncertainty in run reconstruction results.

The run reconstructions reported here represent a systematic application of an analytical technique that allows the fisheries managers and analysts to combine all the available information for northern boundary fisheries into a single process to better understand the relative and potential contributions of major stocks to each fishery. Since managers must make some assumptions regarding the stocks present in each fishery before permitting fisheries to take place, these types of models provide a means of documenting and systematically evaluating these assumptions. They also provide a consistent procedure for post season analyses and catch accounting that is necessary for examining stock trends, alternative management options and assessing management performance with respect to catch allocation goals.

While the uncertainty associated with the above run reconstructions must be acknowledged, so must the potential benefits of the further development and application of run reconstruction techniques. The inputs to the model specify clear requirements for data collection and organization which alone would be of significant benefit to fisheries managers. The process of organizing the data required for run reconstruction analyses reveals data gaps and assumptions critical to the interpretation of annual harvest statistics. The combined assessment of northern B.C. and Alaskan stocks promotes an increased understanding of each others stocks and fisheries and an ongoing need to work cooperatively in the management and assessment of these valuable stocks.

## ACKNOWLEDGEMENTS

The work reported here would not have been possible without the cooperation and support of key individuals in the management and assessment of northern British Columbia and southeast Alaskan salmon fisheries. Within Fisheries and Oceans, Canada, we would like to thank Dave Peacock for guiding all aspects of the project; Les Jantz, Linda Orman and Don Radford for their quick responses to many questions regarding northern B.C. fisheries data; and Chris Wood, Steve Cox-Rogers and Skip McKinnell for their constructive comments and suggestions. Within the Alaska Department of Fish and Game we thank Ben Van Allen and Larry Talley for coordinating the transfer of detailed catch and escapement data for southern southeast Alaska; Jerome Pella, Jim Blick and Scott Marshal for their review of preliminary model results. Funding for this project was provided through the Skeena River Green Plan and Nisga'a Tribal Council Interim Measures Program.

## LITERATURE CITED

- Blackbourne, D.J. 1987. Sea surface temperature and the prediction of return timing in Fraser River sockeye salmon (*Oncorhynchus nerka*), p. 296-306. In H.D. Smith, L. Margolis, and C.C. Wood [ed.] Sockeye salmon (*Oncorhynchus nerka*) population biology and future management, Can. Spec. Publ. Fish. Aquat. Sci. 96.
- Cave J. and W.J. Gazey. 1994. A simulation model for fisheries on Fraser River sockeye salmon. J. Fish. and Aquat. Sci. 51:1535-1549.
- English, K.K., W.J. Gazey and J.A. Taylor. 1984. Part C. The 1983 North Coast Salmon Tagging Project. In: Gazey, W.J. and D.A. Birdsall (eds.). Design and execution of a stock interception study. Unpubl. Rep. by LGL Limited for Fisheries and Oceans Canada.
- English, K.K., W.J. Gazey, A.R. Maltby and J.A. Taylor. 1985a. Part D. The 1984 North Coast Salmon Tagging Project. In: Gazey, W.J. and D.A. Birdsall (eds.). Design and execution of a stock interception study. Unpubl. Rep. by LGL Limited for Fisheries and Oceans Canada.
- English, K.K., D. Hall and J. Taylor. 1985b. The North Coast Tagging Project: Management Information. Volumes A, B, C, and D. Unpubl. Reps. by LGL Limited for Fisheries and Oceans Canada.
- Gable, J., and S. Cox-Rogers. 1993. Stock identification of Fraser River sockeye salmon: methodology and management application. Pac. Salmon Comm. Tech. Rep. 5.
- Gazey W.J. 1992. Stock reconstruction for Fraser River Stocks. Unpubl. Rep. by W.J. Gazey Research for the Pacific Salmon Commission.
- Gazey, W.J. 1983. Theoretical development, design and data management. In: W.J. Gazey and D.A. Birdsall (eds.). Design and execution of a stock interception study: the 1982 North Coast Salmon Tagging Project. Fin. Report by LGL for Dep. of Fisheries and Oceans.
- Gazey, W.J., K.K. English and K. McGivney. 1989. South Coast management model: third edition. Unpubl. Rep. by W.J. Gazey Research and LGL Limited for Fisheries and Oceans Canada.

**LITERATURE CITED (cont'd)**

- Gazey, W.J., J.A. Taylor and T.M. Webb. 1983. The 1982 North Coast Salmon Tagging Project. In: W.J. Gazey and D.A. Birdsall (eds.). Design and execution of a stock interception study: The 1982 North Coast Salmon Tagging Project. Fin. Rep. by LGL Ltd. for Dep. of Fisheries and Oceans.
- Pacific Salmon Commission. in prep. Forth Report on the Parties Estimates of Salmon Interceptions - 1980-1997, Report JIC (98)-?.
- Pacific Salmon Commission. 1994. Report of the Fraser River Panel to the Pacific Salmon Commission on the 1991 Fraser River sockeye and pink salmon fishing season. Pacific Salmon Commission.
- Pacific Salmon Commission. 1995. Pacific Salmon Commission Run Size Estimation Procedures: Analysis of the 1994 shortfall in escapement of late-run Fraser River sockeye salmon. PSC Tech. Rep. No. 6. 179p.
- Pella, J., M. Hoffman, M. Hoffman, S. Hoffman, M. Masuda, S. Nelson and L. Tally. 1993. Adult sockeye and pink salmon tagging experiments for separating stocks in Northern British Columbia and Southeast Alaska, 1982-1985. NOAA Technical Memorandum NMFS-AFSC-18.
- Starr, P., and R. Hilborn. 1988. Reconstruction of harvest rates and stock contribution in gauntlet salmon fisheries: application to British Columbia and Washington sockeye (*Oncorhynchus nerka*). Can J. Fish. Aquat. Sci 45: 2216-2229.
- Taylor, J.A., K.K. English and W.J. Gazey. 1986. Part E. The 1985 North Coast Salmon Tagging Project. In: Gazey, W.J. and D.A. Birdsall (eds.). Design and execution of a stock interception study. Unpubl. Rep. by LGL Limited for Fisheries and Oceans Canada.



**TABLES**

Table 1. Definition of Canadian fisheries based on hail survey data.

No	Fishery	Definition	1982-83	1984	1985	1986-92
1	Langara	Area 1 Net	1-2, 1-3, 1-4	1-2, 1-3, 1-4	1-2, 1-3, 1-4	1-2, 1-3, 1-4
2	1TN	Area 1 Troll North	101-4	101-4	101-4 (<July 22)	101-4 (<July 22)
3	1TS	Area 1 Troll South	101-other	101-other	101-other	101-other
4	Masset	Masset Inlet	1-6	1-6	1-6	1-6
5	3X	Dundas Is. West	3X	3X	3-1	3-1W
6	3Y+7	Dundas - China Hat	3Y, 3Z(seine)	3Y, 3Z(seine)	3Y, 3-7(seine)	3-1E, 3-3-1, 3-3-2 3-4, 3-7-2
7	3Z-7	Above China Hat	3Z(gillnet)	3Z(gillnet)	3-7(gillnet), 3-9 3-12, 3-17	3-7-1, 3-9, 3-11 3-12, 3-14, 3-17
8	4W	Outside Area 4	15,16,17,18,19,20	4,5,6	4,5,6	4,5,6
9	4X	Lower Chatham Sound	14	3	3	3
10	4Y	Smith		2	2	2
11	4Z	River/Gap/Slough	11,12,13	1	1	1
12	Area 5	Area 5 Net	5-all	5-all	5-all	5-all

**Area 1 Fishery Codes**

1-2	Langara Island
1-3	Virago Sound
1-4	Naden Harbour
1-6	Masset Inlet
101-4	A-B line Troll
101-other	Dixon Entrance Troll

**Area 4 Fishery Codes (1982-83)**

1	River/Gap/Slough
2	Smith
3	North Porcher
4	North Boundary
5	Hudson Bay Pass
6	Outside Areas

**Area 3 Fishery Codes**

3X	Dundas Island
3Y	Tracy Bay - Boston Rocks
3Z	Portland Inlet
3-1W	Dundas Island West
3-1E	Dundas Island East
3-3-1	Boston Rocks
3-3-2	Tracy Bay
3-4	Finlayson Island
3-7-1	Area 3-7 above China Hat
3-7-2	Area 3-7 below China Hat
3-9	Nasoga Gulf
3-11	Pearse Island
3-12	Kincolith
3-14	Observatory Inlet
3-17	Dogfish Bay

**Area 4 Fishery Codes (1984-92)**

11	Slough
12	River
13	Gap
14	Lower Chatham Sound
15	Upper Chatham Sound
16	North Boundary
17	Hudson Bay Pass
18	Outer Stephens
19	Edye Pass
20	Oval Bay

Table 2. Definition of Alaskan fisheries based on Pella et al. (1993).

No. Fishery	Definition	Alaska Sub-Districts
20 Noyes	Noyes Island	103-50, 103-60, 103-65, 103-70, 103-80, 103-90 104-30, 104-35, 104-40, 104-50
21 Dall	Dall Island	104-10, 104-20
22 Cordova	Cordova Bay	103-11, 103-15, 103-21, 103-23, 103-25, 103-30, 103-40
23 Sumner	Sumner Strait	106-41
24 U.Clar	Upper Clarence Strait	106-10, 106-20, 106-30
25 M. Clar	Middle Clarence Strait	102-70, 102-80
26 L. Clar	Lower Clarence Strait	101-21, 101-25, 101-27, 101-28, 101-29, 102-10, 102-20, 102-40, 102-5
27 Revilla	Revilla	101-23, 101-24, 101-26, 101-30, 101-33, 101-41 101-41, 101-43, 101-44, 101-45, 101-47, 101-53
28 Union	Union Bay	107-10
29 Fox	Cape Fox (Tree Point)	101-11
30 Term101	Terminal District 101	101-80, 101-85, 101-90, 101-95
31 Term105	Terminal District 105	105-10, 105-41, 105-42, 105-43, 105-50
32 Term108	Terminal District 108	108-10, 108-20, 108-30, 108-40, 108-45, 108-50, 108-60, 107-20

Table 3. Definition of sockeye and pink salmon stocks included in run reconstructions.

No.	Stock	Definition	Location
<b>Sockeye Stocks</b>			
1	Skeena	Skeena River	Statistical Area 4-15
2	Nass	Nass River	Statistical Area 3-18
3	Stikine	Stikine River	District 108-40
4	US McD	McDonald Lake	District 101-80
5	US Other	Alaskan Other	Districts 101, 102, 103, 105, 107
6	Fraser	Fraser River	Statistical Area 29
<b>Pink Stocks</b>			
1	Skeena	Skeena River	Statistical Area 4-15
2	A4-Is.	Area 4 Islands	Statistical Area 4-1, 4-2, 4-3, 4-5, 4-9
3	A3-In	Area 3 Inside	Statistical Area 3-7, 3-9, 3-10, 3-12, 3-18
4	A3-Out	Area 3 Outside	Statistical Area 3-1 to 3-6
5	Area 5	Area 5	Statistical Area 5
6	South	Southern B.C.	Area 6, Area 8 and Fraser River
7	Yakoun	Yakoun River	Area 1
8	US101	US101	District 101
9	US102	US102	District 102
10	US103/4	US103 and US104	District 103 and 104
11	US105/6	US105 and US106	District 105 and 106
12	US107/8	US107 and US108	District 107 and 108

Table 4. Total annual sockeye catch by fishery and escapement by stock.

	1982	1983	1984	1985	1986	1987	1988	1989	1990	1991	1992	1993	1994	1995	Mean Percent	
<b>Catch (thousands)</b>																
Langara	59	32	28	109	32	35	42	87	63	57	86	221	114	105	76	2.6%
1TS	4	4	18	33	21	45	52	114	27	32	16	0	0	0	26	0.9%
3X	312	96	120	234	48	40	172	70	46	288	197	270	73	596	183	6.2%
3Y+7	142	305	75	119	121	211	117	339	160	497	412	575	235	752	290	9.9%
3Z-7	192	45	75	56	27	44	15	33	10	99	381	504	39	115	117	4.0%
4W	789	115	194	596	63	90	207	119	144	215	490	582	237	589	316	10.8%
4X	337	49	122	408	94	94	226	94	100	137	235	313	109	290	186	6.3%
4Y	0	0	158	395	117	128	393	145	268	285	463	268	115	361	221	7.5%
4Z	497	119	263	634	186	202	679	264	310	352	452	510	190	412	362	12.3%
Area 5	70	14	35	55	31	39	40	22	51	46	72	42	36	50	43	1.5%
Noyes	191	510	163	309	242	92	388	317	484	482	615	499	770	249	379	12.9%
Dall	91	141	134	139	210	79	204	192	323	382	458	486	371	256	248	8.4%
Cordova	1	1	1	10	6	1	2	8	9	5	3	9	10	3	5	0.2%
Summer	122	28	27	172	85	79	57	108	105	89	147	130	157	133	103	3.5%
U.Clar	72	23	66	94	61	57	35	88	82	56	57	76	55	79	64	2.2%
M.Clar	0	4	2	2	3	0	0	5	5	1	6	8	6	23	5	0.2%
L.Clar	60	37	65	90	50	18	21	85	77	59	52	214	62	190	77	2.6%
Revilla	29	16	34	43	39	43	25	78	25	37	63	13	15	39	36	1.2%
Fox	190	136	88	173	146	107	116	145	86	131	245	394	100	164	159	5.4%
Term101	1	0	3	18	12	0	0	1	0	8	23	99	0	7	12	0.4%
Term108	7	0	1	1	4	2	1	12	11	24	53	70	98	76	26	0.9%
Total	3166	1675	1672	3690	1598	1406	2792	2326	2386	3282	4526	5283	2792	4489	2935	
<b>Escapement (thousands)</b>																
Skeena	1303	1012	1220	2354	841	1436	1526	1260	1145	1372	1547	1952	1205	2064	1446	60.8%
Nass	340	209	221	398	236	219	163	139	179	345	687	584	345	312	313	13.2%
Stikine	69	72	76	185	69	39	42	75	57	120	155	176	128	142	100	4.2%
US MacD	57	56	124	121	108	138	73	82	120	188	146	243	117	52	116	4.9%
US Other	297	268	421	396	339	525	230	262	351	565	687	753	372	162	402	16.9%
Total	2066	1617	2062	3454	1593	2357	2034	1818	1852	2590	3222	3708	2167	2732	2377	

Table 5. Comparison of tagging study estimates of migration proportions with the routing parameters used in the run reconstructions for Skeena and Nass sockeye stocks.

Fisheries		Tagging Study			Routing Parameters		
To:	From:	1982	1983	Diff	1982	1983	Diff
<b>Skeena</b>							
4X	4W	0.89	0.90	-0.01	0.50	0.51	-0.01
	Area 5	0.11	0.10	0.01	0.25	0.28	-0.03
	Exit	0.00	0.00	0.00	0.25	0.21	0.04
4W	3Y+7	0.16	0.42	-0.26	0.15	0.26	-0.11
	3X	0.58	0.38	0.20	0.85	0.75	0.10
	1TS	0.26	0.20	0.06	0.00	0.00	0.00
3X	1TS	0.32	0.11	0.21	0.50	0.50	0.00
	Fox	0.78	0.89	-0.11	0.50	0.50	0.00
3Y+7	3X	0.10	0.07	0.03	0.40	0.75	-0.35
	Fox	0.90	0.93	-0.03	0.60	0.25	0.35
L. Clar	1TS	0.23	0.15	0.08	0.30	0.10	0.20
	Cordova	0.70	0.17	0.53	0.55	0.77	-0.22
	M. Clar	0.07	0.68	-0.61	0.15	0.13	0.02
1TS	Dall	0.41	0.62	-0.21	0.05	0.50	-0.45
	Langara	0.59	0.38	0.21	0.50	0.50	0.00
	Exit	0.00	0.00	0.00	0.45	0.00	0.45
<b>Nass</b>							
3Y+7	Fox	0.64	0.71	-0.07	0.22	0.21	0.01
	3X	0.07	0.05	0.02	0.28	0.25	0.03
	4W	0.29	0.24	0.05	0.50	0.54	-0.04
4W	4X	0.02	0.66	-0.64	0.15	0.80	-0.65
	3X	0.98	0.34	0.64	0.00	0.20	-0.20
	Exit	0.00	0.00	0.00	0.85	0.00	0.85
3X	1TS	0.32	0.11	0.21	0.50	0.05	0.45
	L. Clar	0.68	0.89	-0.21	0.50	0.95	-0.45
L. Clar	1TS	0.23	0.15	0.08	0.30	0.00	0.30
	Cordova	0.70	0.17	0.53	0.57	0.84	-0.27
	M. Clar	0.07	0.68	-0.61	0.13	0.16	-0.03
1TS	Dall	0.41	0.62	-0.21	0.18	0.18	0.00
	Langara	0.59	0.38	0.21	0.82	0.82	0.00

Table 6. Comparison of sockeye stock interception estimates derived from tagging and run reconstruction.

	Tagging Study				Run Reconstruction				Difference			
	Skeena	Nass	Stikine	U.S.	Skeena	Nass	Stikine	U.S.	Skeena	Nass	Stikine	U.S.
<b>1982</b>												
Langara	70	19		11	70	19		11	0	0		0
3X	82	14		4	80	14		6	2	0		-2
3Y+7	34	61		5	32	62		6	2	-1		-1
4W	76	16		8	79	18		3	-3	-2		5
A5	92	7		1	91	7		2	1	0		-1
Noyes	59	20		21	60	19		21	-1	1		0
Dall	61	18		21	61	17		22	0	1		-1
Sumner												
U. Clar	56	13		31	55	13	4	28	1	0		-1
M. Clar	56	13		31	56	14		30	0	-1		1
Tree	38	34		28	37	36		27	1	-2		1
<b>1983</b>												
Langara	70	26		4	70	27		3	0	-1		1
3X	85	14		1	83	15		2	2	-1		-1
3Y+7	41	57		2	41	58		3	0	-1		-1
4W	76	23		1	73	25		2	3	-2		-1
A5	62	31		7	63	33		4	-1	-2		3
Noyes	70	21		9	68	22		9	2	-1		0
Dall	55	40		5	57	37		6	-2	3		-1
Sumner	18	12	20	50	21	12	19	48	-3	0	1	2
U. Clar	28	15	4	53	25	15	5	55	3	0	-1	-2
M. Clar	29	15		56	27	15		58	2	0		-2
Tree	47	42		11	46	43		11	1	-1		0

Table 7. Percent of a sockeye stock that passes through each fishery in the absence of fishing during 1982 and 1983.

Fishery	Skeena		Nass		Stikine		US MacD		US Other	
	1982	1983	1982	1983	1982	1983	1982	1983	1982	1983
Langara	28.2	27.3	33.7	35.1	0.0	0.0	35.0	3.0	10.8	0.3
1TS	56.4	54.6	41.0	42.8	0.0	0.0	35.0	3.0	10.8	0.3
3X	47.0	47.7	45.5	35.8	0.0	0.0	35.0	3.0	10.8	0.3
3Y+7	7.5	13.0	100.0	100.0	0.0	0.0	28.5	2.4	9.1	0.7
3Z-7	0.0	0.0	100.0	100.0	0.0	0.0	0.0	0.0	0.0	0.0
4W	50.0	51.0	50.0	54.0	0.0	0.0	0.0	0.0	5.4	0.6
4X	100.0	100.0	32.5	43.2	0.0	0.0	0.0	0.0	0.5	0.6
4Y	100.0	100.0	0.0	0.0	0.0	0.0	0.0	0.0	0.0	0.0
4Z	100.0	100.0	0.0	0.0	0.0	0.0	0.0	0.0	0.0	0.0
Area 5	25.0	28.0	4.9	41.0	0.0	0.0	0.0	0.0	0.5	0.6
Refuge	50.4	21.0	27.6	2.2	0.0	0.0	0.0	27.5	0.0	22.6
Noyes	17.4	48.2	32.9	53.9	0.0	0.0	40.0	27.5	61.1	22.6
Dall	16.7	27.3	25.2	53.9	0.0	0.0	40.0	11.0	61.1	9.0
Cordova	14.6	20.9	25.5	46.2	0.0	0.0	40.0	55.0	61.1	45.1
Sumner	4.0	3.5	5.8	8.8	100.0	100.0	25.0	42.0	27.6	54.0
U.Clar	4.0	3.5	5.8	8.8	20.0	20.0	25.0	42.0	27.6	54.0
M.Clar	4.0	3.5	5.8	8.8	0.0	0.0	25.0	42.0	25.6	48.0
L.Clar	26.5	27.1	44.8	55.0	0.0	0.0	100.0	100.0	61.1	45.1
Revilla	0.0	0.0	0.0	0.0	0.0	0.0	0.0	0.0	64.7	10.0
Fox	3.0	3.3	22.0	21.0	0.0	0.0	35.0	3.0	22.6	3.5
Term101	0.0	0.0	0.0	0.0	0.0	0.0	100.0	100.0	0.0	0.0
Term108	0.0	0.0	0.0	0.0	100.0	100.0	0.0	0.0	0.0	0.0



Table 8. Estimates of total run size and exploitation rates for sockeye stocks derived using two approaches: 1) assuming equal vulnerability; and 2) using all available stock composition estimates for Alaskan fisheries derived from scale data.

	1982	1983	1984	1985	1986	1987	1988	1989	1990	1991	1992	1993	1994	1995	Mean	Percent
<b>Equal Vulnerability</b>																
Stock Size (thousands)																
Skeena	3,575	1,954	2,368	5,329	1,846	2,385	4,041	2,591	2,780	3,520	4,103	4,406	2,473	5,279	3,313	64%
Nass	896	584	488	709	509	438	304	428	323	982	2,067	2,497	964	1,258	889	17%
Stikine	105	79	81	230	85	48	51	111	84	165	242	271	281	248	152	3%
US MacD	120	97	182	218	195	172	99	151	205	311	249	496	209	128	209	4%
US Other	524	388	568	588	528	698	321	504	527	796	956	981	567	282	593	11%
Alaska %	12%	16%	20%	11%	23%	23%	9%	17%	19%	19%	16%	17%	17%	6%	16%	
<b>Harvest Rate (%)</b>																
Skeena	64	48	48	56	54	40	62	51	59	61	62	56	51	61	54.5	
Nass	62	64	55	44	54	50	46	68	45	65	67	77	64	75	59.5	
Stikine	35	9	6	20	19	18	17	32	32	27	36	35	55	43	26.8	
US MacD	53	42	32	45	45	20	27	46	41	40	41	51	44	60	41.1	
US Other	43	31	26	33	36	25	28	48	33	29	28	23	34	42	32.0	
<b>Using Alaska Scale Data</b>																
Stock Size (thousands)																
Skeena	3,471	1,879	2,280	5,255	1,715	2,264	3,863	2,560	2,627	3,504	4,095	4,375	2,496	5,191	3,239	63%
Nass	874	538	509	695	605	490	356	418	405	968	1,923	2,392	836	1,221	874	17%
Stikine	111	77	81	215	76	43	45	93	72	162	238	291	273	237	146	3%
US MacD	132	117	196	251	209	185	123	164	244	325	284	526	232	169	233	5%
US Other	629	491	615	658	554	758	421	549	569	803	1,064	1,056	645	345	656	13%
Alaska %	15%	20%	22%	13%	24%	25%	11%	19%	21%	20%	18%	18%	20%	7%	17%	
<b>Harvest Rate (%)</b>																
Skeena	62	46	46	55	51	37	60	51	56	61	62	55	52	60	53.2	
Nass	61	61	57	43	61	55	54	67	56	64	64	76	59	74	60.8	
Stikine	38	7	6	14	9	9	7	19	20	26	35	39	53	40	21.8	
US MacD	57	52	37	52	48	25	40	50	51	42	49	54	50	69	47.6	
US Other	53	45	32	40	39	31	45	52	38	30	35	29	42	53	39.3	

Table 9. Differences for sockeye stocks between the run reconstruction results based on equal vulnerability and those derived using scale data, expressed as a percent of the estimates based on equal vulnerability.

	1982	1983	1984	1985	1986	1987	1988	1989	1990	1991	1992	1993	1994	1995	Mean	Percent
<b>Stock Size (% change)</b>																
Skeena	3	4	4	1	7	5	4	1	6	0	0	1	-1	2	2	1
Nass	2	8	-4	2	-19	-12	-17	2	-25	1	7	4	13	3	2	0
Stikine	-6	3	0	7	11	10	12	16	14	2	2	-7	3	4	4	0
US MacD	-10	-21	-8	-15	-7	-8	-24	-9	-19	-5	-14	-6	-11	-32	-12	0
US Other	-20	-27	-8	-12	-5	-9	-31	-9	-8	-1	-11	-8	-14	-22	-11	-1
Alaska (% change)	-18	-25	-8	-13	-6	-8	-30	-9	-11	-2	-12	-7	-13	-26	-11	
<b>Harvest Rate (difference)</b>																
Skeena	2	2	2	1	3	3	2	0	3	0	0	1	-1	1	1	
Nass	1	3	-2	1	-7	-5	-8	1	-11	1	3	1	5	1	-1	
Stikine	-3	2	0	6	10	9	10	13	12	1	1	-4	2	3	5	
US MacD	-4	-10	-5	-7	-3	-5	-13	-4	-10	-2	-8	-3	-6	-9	-7	
US Other	-10	-14	-6	-7	-3	-6	-17	-4	-5	-1	-7	-6	-8	-11	-7	

Table 10. Percent contribution of Alaskan sockeye salmon stocks to northern boundary fisheries, derived from run reconstructions using all available Alaskan scale data.

Fishery	1982	1983	1984	1985	1986	1987	1988	1989	1990	1991	1992	1993	1994	1995	Mean
Langara	6	5	0	1	3	3	1	2	1	2	2	1	1	2	2.1
1TS	4	9	0	0	6	3	0	1	6	4	6	0	0	0	2.8
3X	9	2	3	0	1	2	0	3	2	2	1	1	1	1	2.0
3Y+7	15	6	7	3	5	4	2	7	5	4	3	2	2	1	4.7
3Z-7	0	0	0	0	0	0	0	0	0	0	0	0	0	0	0.0
4W	2	3	1	1	1	2	1	2	1	1	1	1	1	0	1.3
4X	0	1	2	0	1	1	0	1	0	1	1	1	1	0	0.7
4Y	0	0	0	0	0	0	0	0	0	0	0	0	0	0	0.0
4Z	0	0	0	0	0	0	0	0	0	0	0	0	0	0	0.0
Area 5	1	3	2	1	2	2	2	4	1	2	2	1	1	1	1.8
Noyes	38	22	27	21	22	40	17	10	14	21	17	20	19	15	21.6
Dall	38	22	26	23	22	40	19	13	17	18	18	21	12	16	21.8
Cordova	89	65	87	84	74	100	39	96	92	92	89	88	89	90	83.9
Sumner	50	67	70	48	68	82	88	65	59	54	61	42	56	32	60.1
U.Clar	49	68	69	47	70	83	87	67	64	60	63	43	60	32	61.6
M.Clar		58	56	77	78			77	76		90	95	49	73	72.9
L.Clar	56	42	61	63	76	73	47	29	51	62	66	52	48	31	54.1
Revilla	100	100	100	100	100	100	100	100	100	100	100	100	100	100	100.0
Fox	36	36	39	17	9	23	13	23	16	10	20	11	15	8	19.7
Term101*	100		100	100	100			100		100	100	100	100	100	100.0
Term108*	0	0	0	0	0	0	0	0	0	0	0	0	0	0	0.0

\* Term101 is a terminal fishery for the MacDonald Lake stock and Term108 is a terminal fishery for the Stikine stock.

Table 11. Canadian balance for sockeye salmon catch (thousands) in northern boundary fisheries derived using two types of run reconstructions: 1) assuming equal vulnerability and 2) using scale data for Alaskan fisheries.

Year	Route Year	Canadian Fisheries				Alaskan Fisheries				Canadian Balance
		B.C.	Alaska	Total	%Alaska	B.C.	Alaska <sup>a</sup>	Total	%BC	
<b>Equal Vulnerability</b>										
1982	1982	2,332	70	2,402	3%	507	257	763	66%	437
1983	1983	760	20	781	3%	748	148	896	83%	728
1984	1983	1,077	12	1,088	1%	384	198	583	66%	373
1985	1983	2,625	14	2,638	1%	729	321	1,050	69%	715
1986	1983	726	15	741	2%	580	277	857	68%	565
1987	1983	910	18	929	2%	281	198	479	59%	262
1988	1983	1,936	5	1,942	0%	729	120	849	86%	724
1989	1983	1,255	31	1,286	2%	725	315	1,040	70%	694
1990	1983	1,166	13	1,179	1%	933	274	1,207	77%	920
1991	1983	1,960	48	2,007	2%	923	351	1,274	72%	876
1992	1983	2,779	26	2,804	1%	1,288	433	1,721	75%	1,262
1993	1983	3,261	25	3,286	1%	1,449	551	2,000	72%	1,423
1994	1983	1,141	8	1,149	1%	1,213	433	1,646	74%	1,205
1995	1983	3,251	19	3,270	1%	937	283	1,220	77%	917
Mean		1,798	23	1,822	1%	816	297	1,113	73%	793
<b>Using Alaska Scale Data</b>										
1982	1982	2,329	73	2,402	3%	383	376	759	50%	310
1983	1983	756	25	781	3%	631	264	895	71%	607
1984	1983	1,074	14	1,088	1%	320	257	577	55%	305
1985	1983	2,626	13	2,638	0%	639	409	1,049	61%	627
1986	1983	730	11	741	1%	542	311	853	64%	531
1987	1983	912	16	929	2%	210	267	477	44%	193
1988	1983	1,936	6	1,942	0%	604	237	841	72%	598
1989	1983	1,254	32	1,286	3%	685	354	1,039	66%	653
1990	1983	1,166	14	1,179	1%	863	342	1,205	72%	849
1991	1983	1,978	29	2,007	1%	875	388	1,263	69%	846
1992	1983	2,777	27	2,804	1%	1,139	571	1,710	67%	1,111
1993	1983	3,263	24	3,286	1%	1,311	677	1,988	66%	1,287
1994	1983	1,140	8	1,149	1%	1,109	525	1,634	68%	1,101
1995	1983	3,248	22	3,270	1%	815	373	1,188	69%	793
Mean		1,799	22	1,822	1%	723	382	1,105	65%	701

<sup>a</sup> includes the Alaskan catch of sockeye returning to the Stikine River (a transboundary river)

Table 12. Comparison of the Canadian interception balance for sockeye salmon (thousands) derived from run reconstruction results with estimates computed by the Pacific Salmon Commission Joint Interception Committee (JIC, 1993).

Year	B.C. Catch of Alaskan Stocks			Alaskan Catch of B.C. Stocks <sup>a</sup>			Canadian Balance			
	Recon.	JIC	Diff.	Recon.	JIC	Diff.	Recon.	JIC	Diff.	%Diff.
<b>Equal Vulnerability</b>										
1982	70	55	14	507	496	10	437	441	-4	-1%
1983	20	9	11	748	741	7	728	732	-4	-1%
1984	12	20	-8	384	405	-20	373	385	-12	-3%
1985	14	70	-56	729	664	65	715	594	121	17%
1986	15	12	3	580	569	11	565	557	8	1%
1987	18	20	-1	281	238	43	262	218	44	17%
1988	5	24	-18	729	643	86	724	619	104	14%
1989	31	37	-5	725	752	-26	694	715	-21	-3%
1990	13	19	-6	933	891	42	920	872	48	5%
1991	48	77	-30	923	910	13	876	833	43	5%
1992	26	48	-22	1288	1172	116	1262	1125	138	11%
1993	25	81	-55	1449	1314	135	1423	1233	190	13%
1994	8	33	-25	1213	1156	57	1205	1124	82	7%
1995	19	83	-64	937	927	10	917	844	74	8%
Total	246	342	-96	6540	6308	232	6293	5966	327	5%
<b>Using Alaska Scale Data</b>										
1982	73	55	17	383	496	-114	310	441	-131	-42%
1983	25	9	15	631	741	-110	607	732	-125	-21%
1984	14	20	-5	320	405	-85	305	385	-80	-26%
1985	13	70	-57	639	664	-25	627	594	32	5%
1986	11	12	-1	542	569	-27	531	557	-26	-5%
1987	16	20	-3	210	238	-28	193	218	-25	-13%
1988	6	24	-18	604	643	-39	598	619	-22	-4%
1989	32	37	-4	685	752	-66	653	715	-62	-10%
1990	14	19	-6	863	891	-28	849	872	-23	-3%
1991	29	77	-48	875	910	-35	846	833	13	2%
1992	27	48	-21	1139	1172	-34	1111	1125	-13	-1%
1993	24	81	-57	1311	1314	-3	1287	1233	54	4%
1994	8	33	-24	1109	1156	-47	1101	1124	-23	-2%
1995	22	83	-62	815	927	-112	793	844	-51	-6%
Total	233	342	-110	5751	6308	-557	5518	5966	-447	-8%

<sup>a</sup> excluding the Alaska catch of the Stikine sockeye stock.

Table 13. Total annual pink salmon catch by fishery.

	1982	1983	1984	1985	1986	1987	1988	1989	1990	1991	1992	1993	1994	1995	Mean	Percent
Catch (thousands)																
Langara	18	134	64	225	841	134	104	150	231	240	209	115	77	170	194	0.6%
ITN	13	45	706	154	35	320	23	132	26	72	71	809	190	424	216	0.7%
ITS	43	148	471	533	380	1,189	2,023	1,245	1,139	1,576	695	86	30	860	744	2.4%
Masset	0	0	617	0	0	0	82	0	1,129	0	236	0	0	0	147	0.5%
3X	302	934	598	324	313	179	132	357	196	2,053	332	222	55	1,236	517	1.7%
3Y+7	722	6,227	1,595	2,072	2,496	2,418	365	2,681	831	6,776	1,231	930	351	2,218	2,208	7.1%
3Z-7	22	225	156	236	541	1,082	66	889	55	2,587	187	1,063	29	337	534	1.7%
4W	198	233	423	753	377	375	163	122	124	186	615	206	95	284	297	1.0%
4X	24	107	114	314	185	284	130	301	124	246	347	110	35	145	176	0.6%
4Y	0	0	125	119	149	194	89	203	175	769	196	59	28	530	188	0.6%
4Z	27	299	215	510	677	928	206	350	580	601	583	182	65	527	411	1.3%
Area 5	58	131	577	296	1,491	392	337	320	747	495	215	30	42	233	383	1.2%
Noyes	4,026	13,219	4,251	11,600	10,833	717	2,199	6,646	8,529	18,547	4,127	11,281	6,693	5,438	7,722	25.0%
Dall	807	5,719	3,155	2,238	11,065	957	1,569	6,718	7,145	13,223	4,912	6,083	6,388	9,290	5,662	18.3%
Cordova	593	465	875	2,351	3,543	223	892	1,423	1,887	1,229	571	991	1,614	1,539	1,300	4.2%
Summer	10	74	100	319	105	117	11	418	84	61	38	297	66	154	132	0.4%
U. Clar	15	1,003	350	448	415	126	59	1,151	466	224	56	241	410	500	390	1.3%
M. Clar	0	1,186	212	206	752	0	0	935	613	34	432	561	482	952	455	1.5%
L. Clar	2,524	2,453	4,090	4,335	6,192	403	1,406	11,200	2,867	3,477	2,635	4,481	1,183	9,728	4,070	13.2%
Revilla	2,597	3,361	3,346	3,176	6,187	869	1,384	9,407	2,254	3,631	4,010	1,066	845	5,219	3,382	10.9%
Union	109	685	157	1	147	0	0	875	123	88	289	1,298	375	260	315	1.0%
Fox	343	773	716	691	898	580	221	1,348	574	600	581	481	260	789	633	2.0%
Term101	464	0	410	1,817	479	0	0	53	0	7	89	249	1	0	255	0.8%
Term105	100	236	150	1,337	407	0	18	0	122	711	10	2,581	82	764	466	1.5%
Term108	17	4	5	3	5	3	0	315	14	480	180	747	209	132	151	0.5%
Total	13,032	37,661	23,478	34,058	48,513	11,490	11,479	47,239	30,035	57,913	22,847	34,169	19,605	41,729	30,946	

Table 14. Total annual pink salmon escapement by stock.

	1982	1983	1984	1985	1986	1987	1988	1989	1990	1991	1992	1993	1994	1995	Mean	Percent
Escapement (thousands)																
Skeena	656	2,581	978	2,057	2,089	3,200	721	4,205	2,515	4,728	902	634	202	1,608	1,934	7.7%
A4-Is.	83	73	59	130	234	142	106	469	141	309	38	92	49	166	149	0.6%
A3-In	348	725	494	479	273	349	141	599	118	310	172	278	128	301	337	1.3%
A3-Out	80	13	37	30	102	24	44	43	37	66	24	37	28	48	44	0.2%
Area 5	70	81	162	176	314	128	162	179	212	80	43	39	45	91	127	0.5%
South	0	3,793	0	4,716	0	1,784	0	4,167	0	5,583	0	4,175	0	3,162	1,956	7.7%
Yakoun	350	0	1,106	0	440	0	447	0	1,030	0	681	0	819	0	348	1.4%
US101	5,538	7,002	9,201	9,636	11,321	5,625	3,897	7,127	5,429	5,099	7,772	5,424	4,950	8,704	6,909	27.3%
US102	1,450	2,496	2,391	2,918	4,404	1,295	1,433	2,337	2,769	1,515	2,378	2,352	2,037	1,943	2,266	9.0%
US103/4	5,261	8,078	8,362	11,950	14,903	5,043	3,767	7,310	5,850	6,239	5,026	7,478	6,221	7,918	7,386	29.2%
US105/6	1,487	1,990	1,402	3,909	3,743	977	1,054	2,454	2,292	2,692	1,009	3,111	2,868	3,289	2,306	9.1%
US107/8	1,327	1,001	1,118	2,563	1,599	1,095	926	2,531	1,377	1,904	1,557	1,409	1,531	1,253	1,514	6.0%
Totals																
BC	1,587	7,266	2,836	7,588	3,452	5,627	1,621	9,662	4,053	11,076	1,860	5,255	1,271	5,376	4,895	19.4%
Alaska	15,063	20,567	22,474	30,976	35,970	14,035	11,077	21,759	17,717	17,449	17,742	19,774	17,607	23,107	20,380	80.6%
Total	16,650	27,833	25,310	38,564	39,422	19,662	12,698	31,421	21,770	28,525	19,602	25,029	18,878	28,483	25,275	
% Alaska	90%	74%	89%	80%	91%	71%	87%	69%	81%	61%	91%	79%	93%	81%	81%	81%

Table 15. Comparison of tagging study estimates of migration proportions with the routing parameters used in the run reconstructions for Skeena and US101 pink salmon stocks.

Fisheries		Tagging Study			Model
To:	From:	1982	1983	1984	Routing Parameters
<b>Skeena</b>					
4W	4W	0.91	0.53	0.50	0.88
	Area 5	0.09	0.47	0.50	0.12
4W	3Y+7	0.22	0.03	0.08	0.22
	3X	0.27	0.45	0.68	0.27
	1TS	0.52	0.52	0.24	0.52
3X	1Troll	0.67	0.82	0.62	1.00
	L.Clar	0.08	0.15	0.22	0.00
	Cordova	0.23	0.03	0.16	0.00
3Y+7	3X	0.62	0.37	0.13	0.75
	Fox	0.38	0.63	0.87	0.25
<b>US101</b>					
Revilla	L.Clar	0.48	0.77	0.34	0.60
	Union	0.37	0.00		0.20
	Cordova	0.16	0.00		0.20
	Fox	0.00	0.23	0.66	
Fox	1TS	0.00	0.00		0.20
	3X, 3Y+7	1.00	1.00	1.00	0.30
	Cordova	0.00	0.00		0.45
3Y+7	3X	0.73	0.58	0.43	0.30
	4W	0.27	0.42	0.57	0.30
	Exit	0.00	0.00	0.00	0.40
3X	4W,1TS	0.85	0.98	0.88	0.73
	L.Clar				0.26
	Cordova	0.15	0.02	0.12	
L. Clar	1TS	0.47	0.51	0.44	0.20
	Cordova	0.16	0.38	0.38	0.50
	M.Clar	0.37	0.11	0.18	0.30



Table 16. Comparison of tagging study and run reconstruction estimates of pink salmon stock composition in northern boundary fisheries.

	Tagging Study						Run Reconstruction						Difference												
	Skena	Area 3	Area 5	B.C. South	Yakoun	Total U.S.	Skena	Area 3	Area 5	B.C. South	Yakoun	Total U.S.	Skena	Area 3	Area 5	B.C. South	Yakoun	US101	US102	US103	US105-8	Total U.S.			
1982																									
Langara	1	17	0	0	7	69	6	0	0	75	15	7	6	55	4	12	0	0	71	-14	10	3	-12	0	4
3X	26	18	0	0	0	51	25	25	0	56	25	25	0	40	10	0	0	50	0	0	-7	-5	0	0	6
3Y+7	13	32	0	0	0	55	12	30	0	55	12	30	0	51	7	0	0	58	1	1	1	-7	0	0	-3
3Z-7	0	69	0	0	0	28	18	39	0	31	18	39	0	42	0	0	0	42	-18	30	1	1	0	2	-11
4W	58	4	0	0	0	38	59	9	0	38	59	9	0	32	0	0	0	32	-1	-5	0	0	0	0	6
Area 5																									
Noyes	6	1	0	0	1	19	13	53	7	91	3	2	0	28	17	35	15	95	3	-1	3	-4	18	-8	-4
Dall	5	0	0	0	1	42	6	21	25	94	3	2	1	47	14	20	13	95	3	-2	3	-8	1	12	-1
Cordova	2	0	0	0	0	47	14	12	25	98	3	0	0	55	16	11	16	97	-1	0	-1	-2	1	9	1
M. Clar	0	0	0	0	0	36	50	0	14	100	0	0	0	41	33	0	27	100	0	0	0	18	0	-13	0
L. Clar	2	0	0	0	0	32	35	22	9	98	1	2	0	60	18	8	10	96	1	-2	1	17	14	-1	2
Revilla	8	0	0	0	0	92	4	0	0	92	4	0	0	96	0	0	0	96	4	0	0	0	0	0	-4
Fox	3	19	0	0	0	76	4	21	1	78	4	21	0	71	5	0	0	76	-1	-1	0	-4	0	1	2
1984																									
1TN	13	7	5	0	2	40	22	5	6	73	15	2	3	44	20	5	10	78	-2	5	4	2	0	-4	-5
3X	34	22	7	0	1	29	7	0	0	36	31	18	0	36	9	0	0	45	2	4	1	-2	0	0	-9
3Y+7	12	37	2	0	0	46	3	0	0	49	19	24	0	50	7	0	0	57	-7	13	2	-4	0	0	-8
3Z-7	16	35	5	0	0	42	3	0	0	45	24	34	0	42	0	0	0	42	-8	1	5	3	0	0	3
4W	44	9	9	0	0	24	7	0	0	31	59	4	8	28	0	0	0	28	-15	5	1	7	0	0	3
Area 5	35	7	27	0	0	23	6	0	0	29	43	3	26	28	0	0	0	28	-8	4	1	6	0	0	1
Noyes	5	4	0	0	0	32	11	23	25	91	6	2	0	25	24	33	11	92	-1	2	0	-13	-10	14	-1
Dall	6	4	0	0	1	30	16	38	5	89	5	2	0	43	19	20	9	91	1	2	0	-3	18	-4	-2
L. Clar	1	1	0	0	0	56	38	1	3	98	4	2	0	56	22	9	7	94	-3	-1	0	16	-8	-3	4
Revilla	4	2	0	0	0	94	0	0	0	94	7	0	0	93	0	0	0	93	-3	2	0	0	0	0	1
Fox	17	22	4	0	1	44	12	0	2	57	6	17	5	66	6	0	0	72	11	4	-1	5	0	2	-15

Table 16. continued.

	Tagging Study										Run Reconstruction										Difference											
	Skkena	Area 3	Area 5	B.C.South	Yakoun	US101	US102	US103	US105-8	Total U.S.	Skkena	Area 3	Area 5	B.C.South	Yakoun	US101	US102	US103	US105-8	Total U.S.	Skkena	Area 3	Area 5	B.C.South	Yakoun	US101	US102	US103	US105-8	Total U.S.		
1985																																
Langara	18	4	1	40	28	2	4	4	37	20	3	0	36	0	28	3	10	0	40	-3	1	1	4	0	0	0	0	0	0	0	0	0
1TN	4	2	0	6	63	12	7	7	88	18	1	1	5	0	36	17	5	17	75	-14	1	-1	1	0	27	-5	1	0	27	-5	1	-10
1TS	18	8	1	17	44	3	2	8	56	27	7	1	13	0	36	3	13	0	52	-9	1	0	4	0	7	0	0	0	7	0	0	-11
3X	43	11	4	15	26	1	0	0	27	42	12	4	8	0	26	7	0	0	34	1	-2	0	7	0	0	-6	0	0	0	-6	0	-7
3Y+7	8	30	1	1	59	1	0	0	60	30	20	0	0	0	43	7	0	0	50	-23	10	1	1	0	16	-6	0	0	16	-6	0	10
3Z-7	10	44	0	0	45	1	0	0	46	38	26	0	0	0	35	0	0	0	35	-28	18	0	0	0	10	1	0	0	10	1	0	11
4W	83	2	4	5	5	0	0	1	6	67	3	4	9	0	18	0	0	0	18	16	-1	0	-4	0	-13	0	0	0	-13	0	0	1
Area 5	73	3	17	1	6	0	0	0	6	41	2	18	23	0	17	0	0	0	17	32	1	-1	-22	0	-11	0	0	0	-11	0	0	-11
Noyes	6	2	0	0	32	5	29	27	92	7	1	0	0	0	20	18	36	18	92	-1	1	0	0	0	12	-13	-8	9	0	12	-13	-8
Dall	3	3	0	2	46	11	25	11	92	6	1	0	1	0	36	17	22	17	92	-3	2	0	1	0	10	-6	3	-6	0	10	-6	3
Cordova	1	0	0	0	10	8	77	4	99	8	0	0	0	0	41	19	13	20	92	-7	0	0	0	0	-31	-11	64	-16	7	-31	-11	64
U.Clar	0	0	0	0	26	13	1	60	100	0	0	0	0	0	53	4	0	44	100	0	0	0	0	0	-27	9	1	16	0	-27	9	1
L.Clar	1	1	0	0	54	35	4	5	98	4	2	0	0	0	47	23	11	14	94	-3	-1	0	0	0	7	12	-7	-9	4	7	12	-7
Revilla	8	4	0	0	88	0	0	0	88	12	0	0	0	0	88	0	0	0	88	-4	4	0	0	0	0	0	0	0	0	0	0	0
Fox	14	18	1	0	64	2	0	1	67	10	14	3	7	0	60	6	0	0	66	4	4	-2	-7	0	4	-4	0	1	1	4	-4	0

Table 17. Summary of the differences between the tagging study and run reconstruction estimates of pink salmon stock composition for each northern boundary fishery. Shaded values could be improved as discussed in text.

Fishery	Year	% Difference										% Alaska		
		Skeena	Area 3	Area 5	B. C. South	Yakoun	US101	US102	US103	US105-8	Total U.S	Tagging Study	Run Recon.	
Langara	82	-94	135			4	24	72	-100		5	75	71	
	85	-13	42	117	12		-1	-30	-63		-9	37	40	
Area 1 TS	85	-33	12	46	34		20	-13	-85		7	56	52	
	84	-13	280	244		-42	-10	11	6	-37	-7	73	78	
Area 1TN	85	-80	98	-100	22		74	-30	25	-60	17	88	75	
	82	1	-26				28	-48			13	56	50	
Area 3X	84	8	22	20			-19	-21			-19	36	45	
	85	3	-14	9	81		-1	-85			-20	27	34	
	82	10	5				9	-100			-5	55	58	
Area 3Y	84	-37	53				-8	-56			-14	49	57	
	85	-74	53				36	-86			20	60	50	
	82	-100	75				-34				-27	31	42	
Area 3z	84	-32	3				-1				6	45	42	
	85	-74	67				27				30	46	35	
	82	-1	-54				18				18	38	32	
Area 4W	84	-26	110	10			-16				11	31	28	
	85	24	-22	6	-42		-73				-66	6	18	
	82													
Area 5	84	-20	157	3			-20				3	29	28	
	85	77	89	-5	-95		-64				-64	6	17	
	82	117	-44				-33	-23	50	-55	-4	91	95	
Noyes	84	-13	99				27	-53	-30	135	-1	91	92	
	85	-11	59				59	-73	-21	51	0	92	92	
	82	101	-100				-5	-11	-55	3	88	-1	94	95
Dall	84	11	132				-38	-30	-18	90	-46	-2	89	91
	85	-49	188		80		26	-36	12	-36	0	92	92	
	82	50	-100				-47	92	171	-10	2	98	96	
L. Clar	84	-80	-60				-1	70	-88	-53	4	98	94	
	85	-75	-40				16	54	-64	-63	4	98	94	
	82	-22	-7				8	-83			3	78	76	
Fox	84	183	25	-27			-34	86			-21	57	72	
	85	41	26	-60	-100		6	-67			2	67	66	



Table 19. Estimates of total annual run size and harvest rates for pink salmon stocks.

	1982	1983	1984	1985	1986	1987	1988	1989	1990	1991	1992	1993	1994	1995	Mean	Percent
Stock Size (thousands)																
Skeena	1,126	8,473	3,531	6,027	6,745	8,945	2,704	10,855	6,583	23,599	4,112	2,310	612	6,120	6,553	12%
A4-Is.	110	92	75	159	369	174	134	645	182	484	49	126	56	219	205	0%
A3-In	796	3,307	1,453	1,289	799	1,000	423	1,856	264	2,359	400	1,154	228	978	1,165	2%
A3-Out	126	19	53	40	167	28	61	64	58	110	35	53	34	81	66	0%
Area 5	86	90	254	186	908	151	210	218	253	89	50	42	47	106	192	0%
Yakoun	356	0	1,867	0	534	0	648	0	2,338	0	1,062	0	879	0	549	1%
US101	13,347	21,577	21,085	24,168	34,813	9,145	9,007	31,276	16,247	20,992	19,452	14,873	11,051	26,965	19,571	36%
US102	2,906	10,926	5,762	7,147	12,673	1,733	2,907	8,286	8,412	7,822	5,987	8,137	5,896	9,144	6,981	13%
US103/4	6,685	10,523	10,479	16,249	21,082	5,518	5,059	10,680	8,084	11,495	6,475	14,265	9,647	13,330	10,684	20%
US105/6	1,971	3,871	1,968	6,761	6,339	1,093	1,495	4,228	5,814	6,618	1,760	9,408	5,981	6,769	4,577	8%
US107/8	2,173	2,587	2,261	5,335	3,503	1,356	1,530	6,013	3,569	6,502	3,068	4,249	4,048	2,948	3,510	6%
Alaska %	91%	81%	85%	89%	89%	65%	83%	82%	81%	67%	87%	93%	95%	89%	84%	84%
Harvest Rate																
Skeena	42	70	72	66	69	64	73	61	62	80	78	73	67	74	67.9	
A4-Is.	24	21	21	18	37	18	21	27	23	36	22	26	12	24	23.6	
A3-In	56	78	66	63	66	65	67	68	55	87	57	76	44	69	65.5	
A3-Out	37	32	30	25	39	17	27	33	36	40	32	31	19	41	31.4	
Area 5	18	10	36	5	65	15	23	18	16	10	14	6	6	14	18.3	
Yakoun	2	0	41	0	18	0	31	0	56	0	36	0	7	0	13.6	
US101	59	68	56	60	67	38	57	77	67	76	60	64	55	68	62.3	
US102	50	77	59	59	65	25	51	72	67	81	60	71	65	79	62.9	
US103/4	21	23	20	26	29	9	26	32	28	46	22	48	36	41	29.1	
US105/6	25	49	29	42	41	11	29	42	61	59	43	67	52	51	42.9	
US107/8	39	61	51	52	54	19	39	58	61	71	49	67	62	57	52.9	



Table 21. Canadian balance for pink salmon catch (thousands) in northern boundary fisheries.

Year	Canadian Fisheries				Alaskan Fisheries				Canadian Balance
	B.C.	Alaska	Total	%Alaska	B.C.	Alaska	Total	%BC	
1982	641	785	1,427	55%	372	11,234	11,605	3%	-414
1983	5,036	3,448	8,484	41%	3,707	25,471	29,177	13%	259
1984	3,059	2,603	5,662	46%	1,336	16,479	17,816	8%	-1,267
1985	3,736	1,800	5,535	33%	1,635	26,885	28,520	6%	-165
1986	3,857	3,628	7,485	48%	2,215	38,814	41,028	5%	-1,413
1987	5,712	1,784	7,495	24%	968	3,027	3,995	24%	-815
1988	2,028	1,691	3,719	45%	530	7,229	7,759	7%	-1,160
1989	4,378	2,371	6,749	35%	4,138	36,352	40,490	10%	1,768
1990	4,014	1,342	5,357	25%	1,610	23,067	24,678	7%	268
1991	12,401	3,200	15,601	21%	9,534	32,779	42,313	23%	6,334
1992	2,842	2,074	4,917	42%	1,006	16,924	17,930	6%	-1,069
1993	1,982	1,831	3,812	48%	1,029	29,328	30,356	3%	-802
1994	312	683	995	69%	274	18,334	18,608	1%	-409
1995	4,196	2,768	6,964	40%	1,485	33,280	34,764	4%	-1,284
Mean	3,871	2,143	6,014	41%	2,131	22,800	24,932	9%	-12

Table 22. Comparison of the Canadian interception balance for pink salmon (thousands) derived from run reconstruction results with estimates computed by the Pacific Salmon Commission Joint Interception Committee (JIC, 1998).

Year	B.C. Catch of Alaskan Stock			Alaskan Catch of B.C. Stock			Canadian Balance			
	Recon.	JIC	Diff.	Recon.	JIC	Diff.	Recon.	JIC	Diff.	%Diff.
1982	785	586	199	372	829	-457	-414	242	-656	159%
1983	3,448	3,967	-519	3,707	3,138	569	259	-829	1088	421%
1984	2,603	2,136	467	1,336	1,607	-270	-1,267	-529	-737	58%
1985	1,800	2,565	-765	1,635	1,393	242	-165	-1,172	1008	-612%
1986	3,628	2,276	1,352	2,215	3,365	-1,151	-1,413	1,089	-2502	177%
1987	1,784	2,139	-355	968	1,043	-75	-815	-1,095	280	-34%
1988	1,691	1,658	32	530	879	-349	-1,160	-779	-382	33%
1989	2,371	3,057	-687	4,138	4,194	-55	1,768	1,136	631	36%
1990	1,342	1,288	55	1,610	3,587	-1,977	268	2,299	-2031	-758%
1991	3,200	5,090	-1,890	9,534	6,904	2,630	6,334	1,814	4520	71%
1992	2,074	1,731	344	1,006	1,770	-764	-1,069	39	-1108	104%
1993	1,831	2,532	-701	1,029	1,147	-118	-802	-1,385	583	-73%
1994	683	741	-58	274	613	-338	-409	-129	-280	69%
1995	2,768	3,278	-509	1,485	2,857	-1,372	-1,284	-421	-863	67%
Total	22,651	24,763	-2,112	26,046	26,939	-893	3,395	2,177	1,219	36%



Table 23. Change in sockeye catch interception estimates from application of inappropriate migration route proportions.

Fishery	Skeena	Nass	Stikine	US MacD	US Other
1982					
1N	0	7		-2	-5
3X	11	-2		-3	-7
3Y+7	16	-2		-6	-8
4W	1	1			-2
4X	-3	3			1
Area 5	-22	21			1
Noyes	20	-1		-1	-19
Dall	5	9		-1	-14
Cordova	7	0		3	-10
Sumner	-9	4	-1	0	6
U.Clar	-11	4	-1	1	7
L.Clar	4	2		0	-6
Fox	10	5		-4	-11
1983					
1N	-16	-8		7	17
3X	-20	1		8	11
3Y+7	-21	-3		11	14
4W	-5	-5			9
4X	4	-2			-2
Area 5	18	-15			-3
Noyes	-27	-3		3	27
Dall	-20	-18		4	35
Cordova	-13	0		-2	15
Sumner	6	-3	5	-1	-7
U.Clar	9	-2	2	0	-9
M.Clar	9	0		1	-10
L.Clar	-4	-4		0	8
Fox	-17	-12		11	19

**FIGURES**

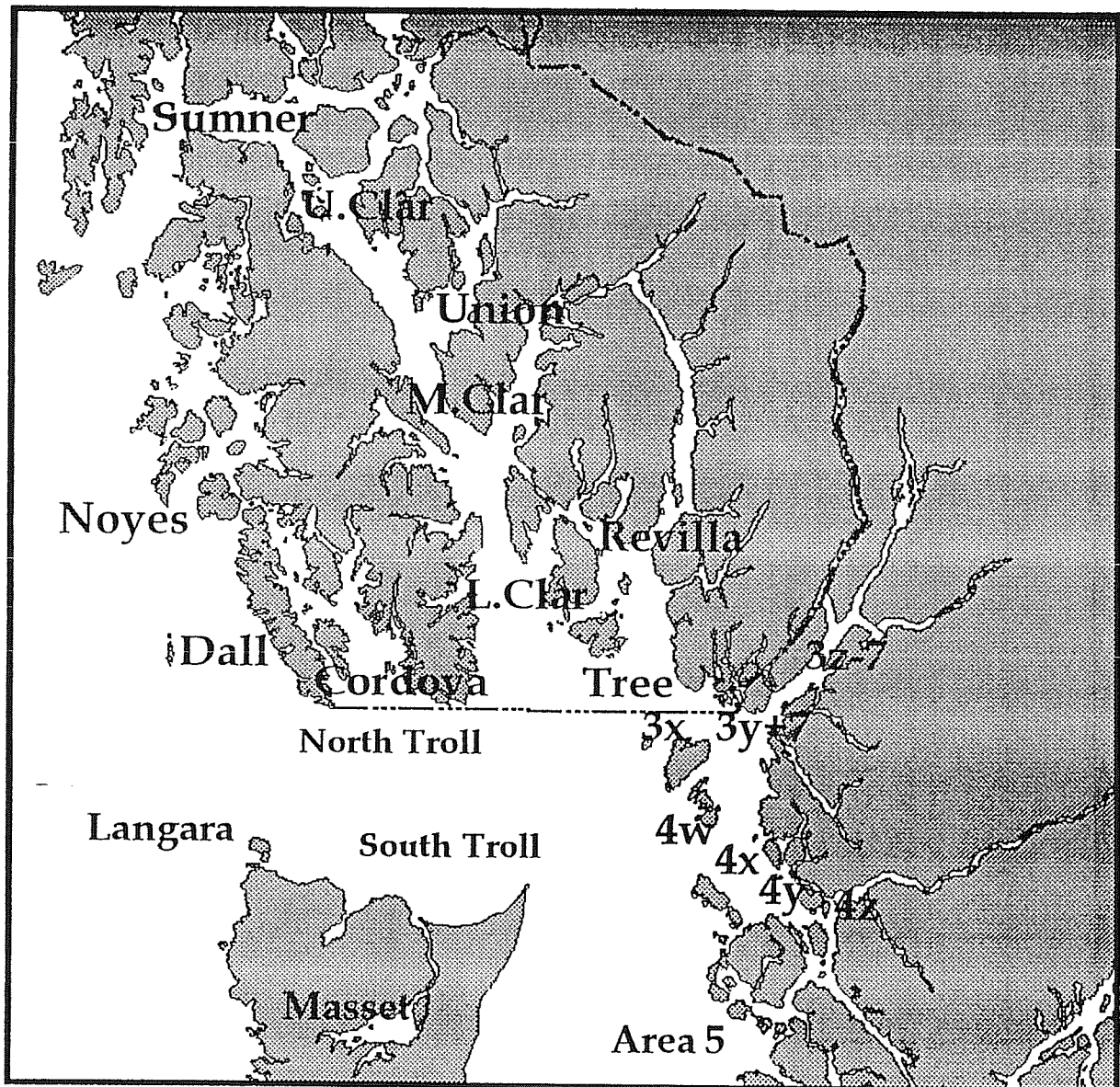

Figure 1. Geographic location of major fisheries in the northern boundary area.

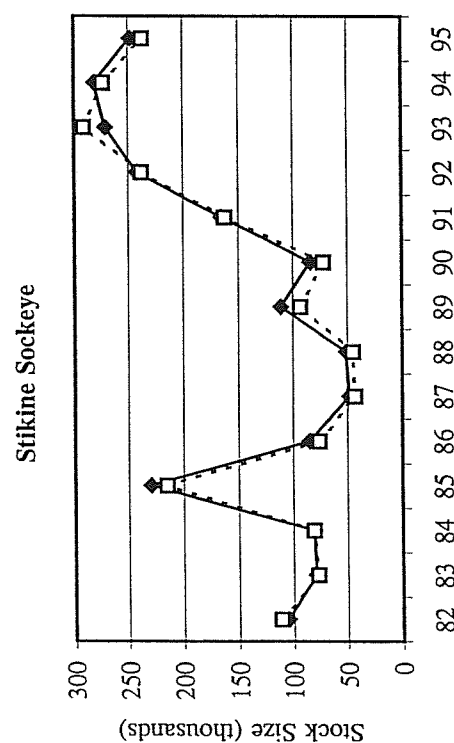
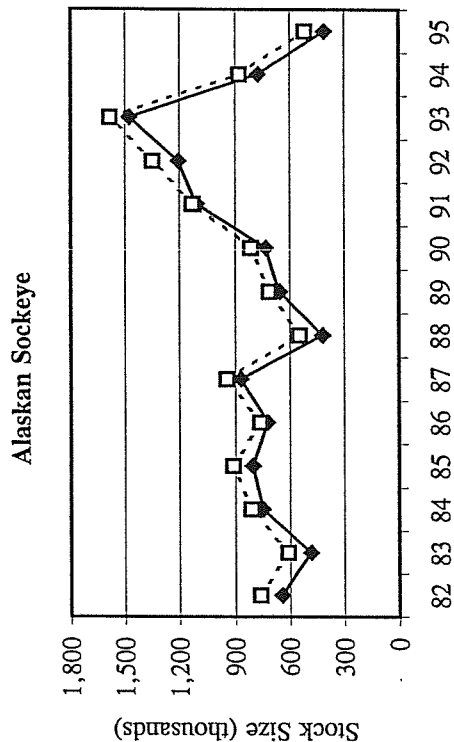
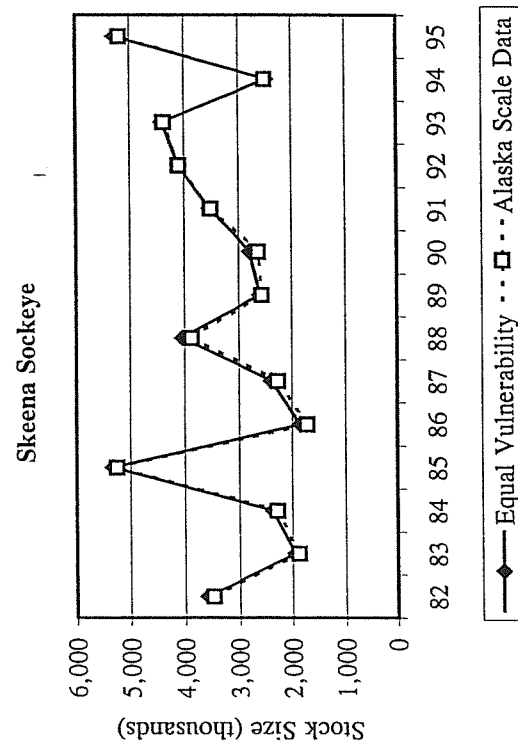
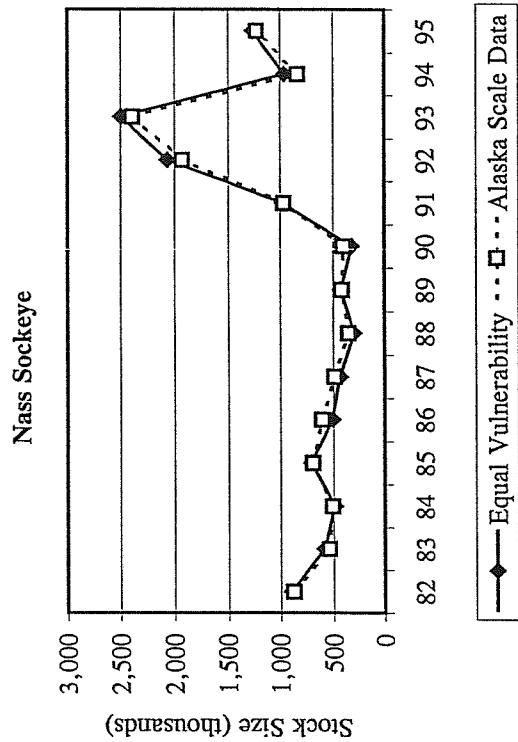

Figure 2. Comparison of stock size estimates for sockeye stocks using two run reconstruction approaches.

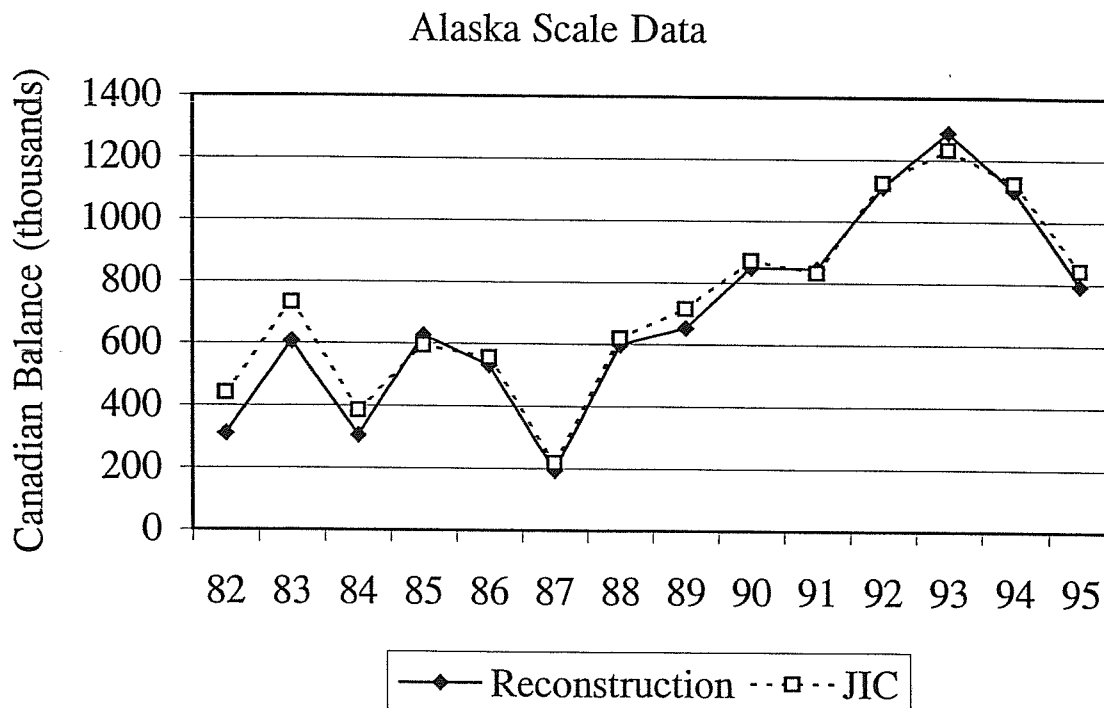
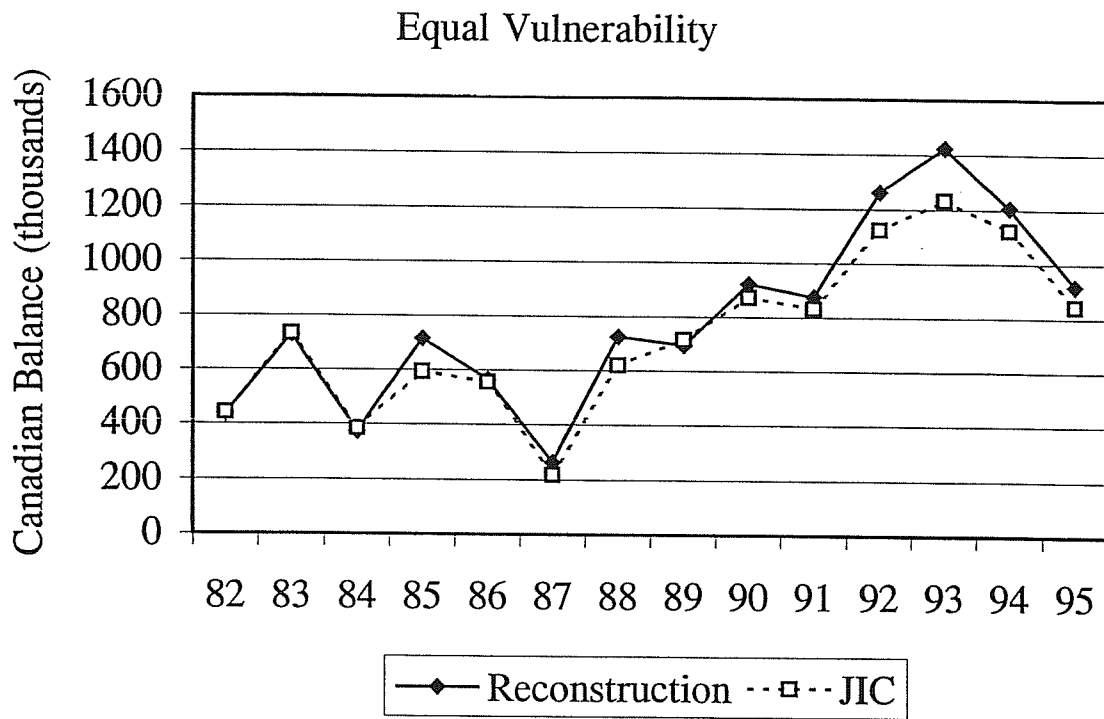
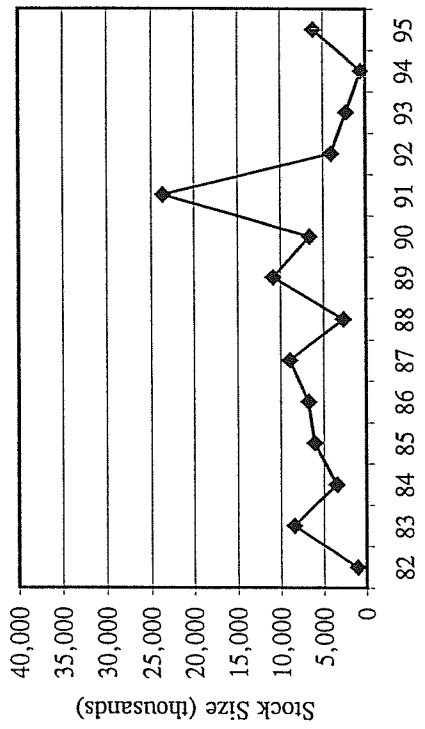
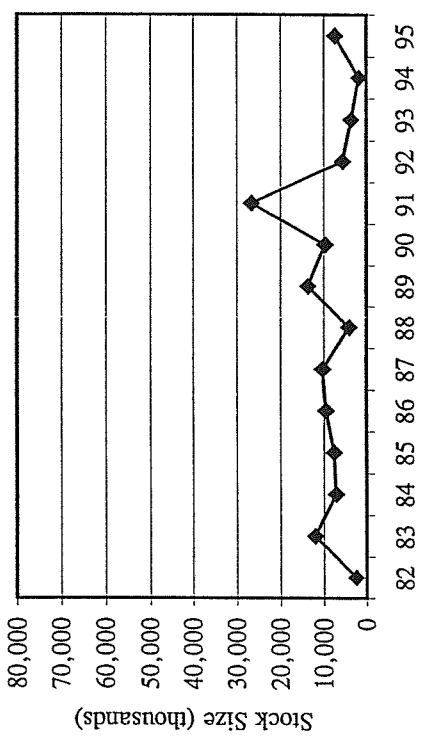

Figure 3. Comparison of the Canadian interception balance for sockeye salmon (thousands) derived from run reconstruction results with estimates computed by the Pacific Salmon Commission Joint Interception Committee (JIC, 1998).

Skeena Pink Salmon



BC Pink Salmon (Area 1,3,4,5)



US 101 Pink Salmon

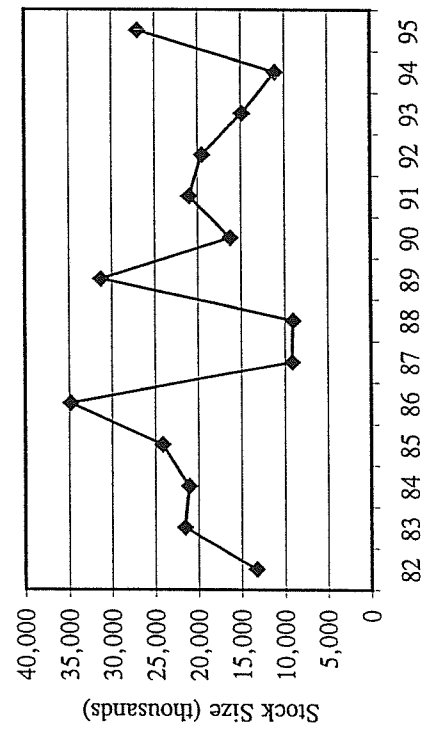

Alaska Pink Salmon (US 101-108)

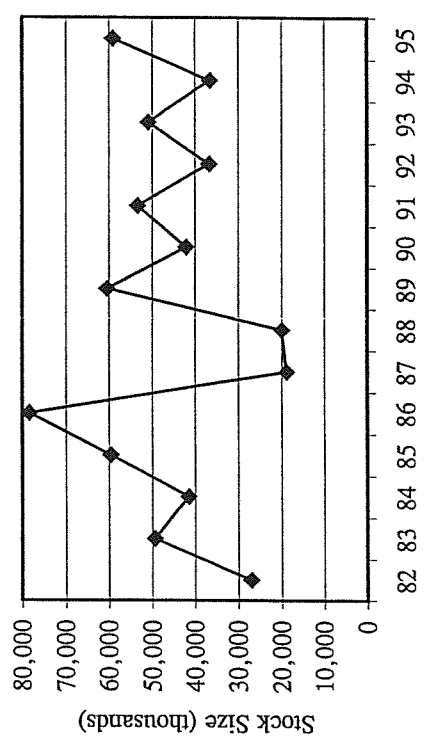

Figure 4. Annual stock size estimates for pink salmon stocks derived from run reconstructions.

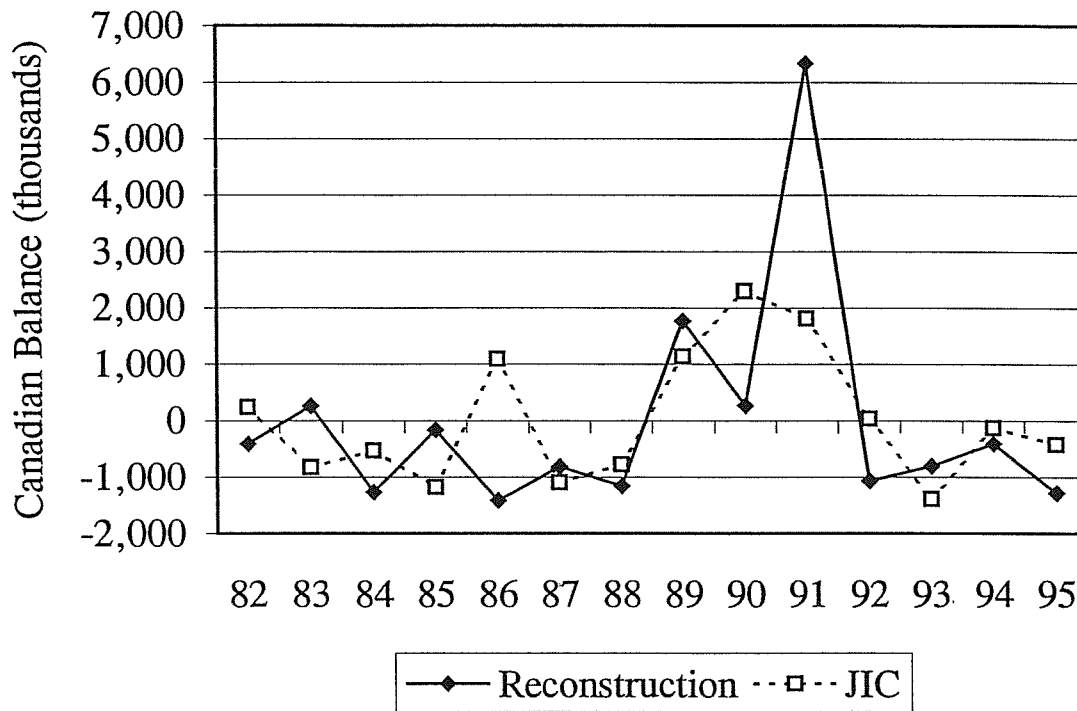

Figure 5. Comparison of the Canadian interception balance for pink salmon (thousands) derived from run reconstruction results with estimates computed by the Pacific Salmon Commission Joint Interception Committee (JIC, 1998).

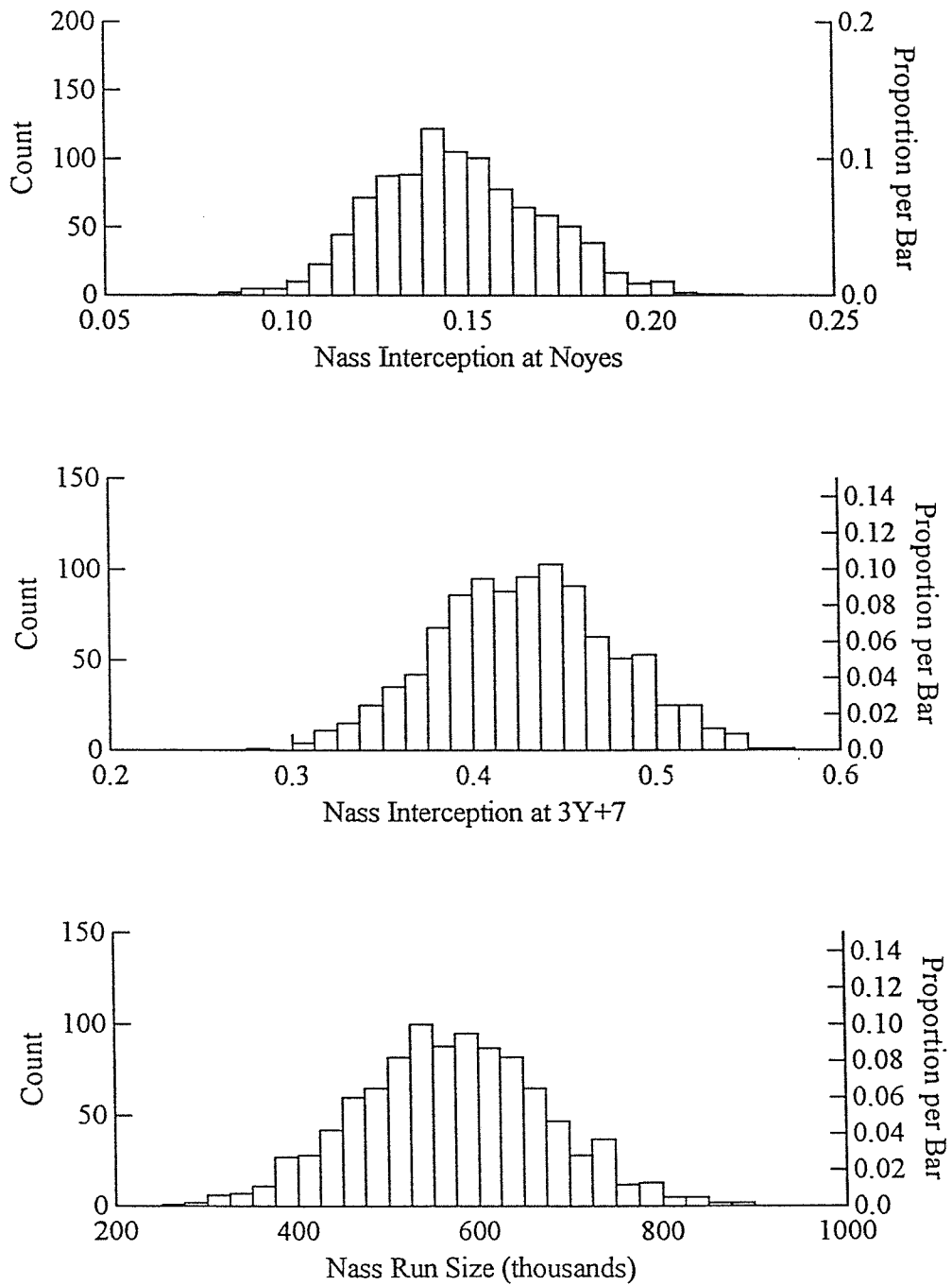

Figure 6. Results of a 1000 Monte Carlo trials of the 1983 sockeye salmon reconstruction. Total escapements and the migration proportions were assumed to exhibit a 0.30 coefficient of variation. All other input data was assumed to be known.



**APPENDICES**

**Appendix A.**

**Area-under-the-curve Method.**

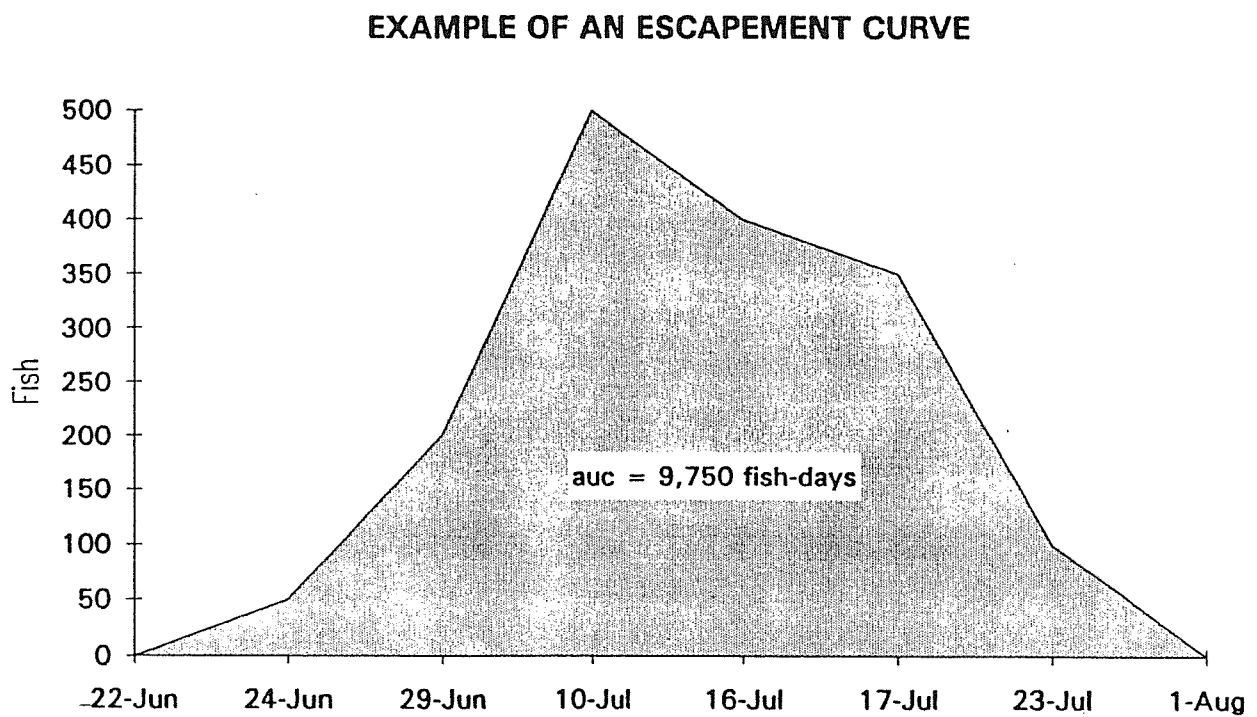

Figure A.1. Example of an escapement curve using hypothetical data presented in Appendix Table A.1 for stream survey Case A.

Appendix Table A.1. Examples of the four AUC categories defined by Johnson and Barrett (1988). Astericks indicated extrapolated counts. The AUC estimate is based on a stream residence time of 15 days.

Date	Stream Survey Case A			Stream Survey Case B			Stream Survey Case C			Stream Survey Case D				
	Julian Day	Interval (days)	Count (fish)	Julian Day	Interval (days)	Count (fish)	Date	Julian Day	Interval (days)	Count (fish)	Date	Julian Day	Interval (days)	Count (fish)
22-Jun	203	2	0	203	2	0	22-Jun	203	2	0	7-Jun	188	15	0 *
24-Jun	205	5	50	205	5	50	24-Jun	205	5	50	22-Jun	203	2	2,500
29-Jun	210	12	200	210	12	1,800	29-Jun	210	12	1,800	24-Jun	205	5	2,700
10-Jul	222	6	500	222	6	1,200	10-Jul	222	6	1,200	29-Jun	210	12	10,000
16-Jul	228	1	400	228	6	7,500	16-Jul	228	6	7,500	10-Jul	222	6	2,000
17-Jul	229	6	350	229	1	9,000	17-Jul	229	1	9,000	16-Jul	228	1	1,500
23-Jul	235	6	100	235	6	15,000	23-Jul	235	6	15,000	17-Jul	229	6	2,000
1-Aug	244	9	0	244	9	20,000	1-Aug	244	9	15,000 *	23-Jul	235	6	4,000
				253	9	15,000 *	7-Aug	250	6	9,000 *	1-Aug	244	9	10,000
				259	6	9,000 *	8-Aug	251	1	7,500 *	10-Aug	253	9	4,000 *
				260	1	7,500 *	14-Aug	257	6	1,200 *	16-Aug	259	6	2,000 *
				266	6	1,200 *	26-Aug	269	12	1,800 *	17-Aug	260	1	1,500 *
				278	12	1,800 *	31-Aug	274	5	50 *	20-Aug	263	3	0 *
				283	5	50 *	2-Sep	276	2	0 *				
				285	2	0 *								
Area-under-the-curve (auc)	9,750			573,050			393,050			305,950				
AUC Estimate (auc / 15)	650			38,203			26,203			20,397				

**Appendix B.**  
**Sockeye Migration Routing Parameters.**

## Appendix B - 1982 Sockeye Migration Routing Parameters

B-1

## SOCKEYE FISHERIES ORDER

Fishery Order			Simultaneous		
Code	Label	Resid	Code	Label	Resid
32	Term108	1			
27	Revilla	2			
30	Term101	2			
12	Area 5	1			
11	4Z	2			
10	4Y	1			
9	4X	1			
8	4W	1			
7	3Z-7	2			
6	3Y+7	3			
5	3X	1			
29	Fox	1	26	L.Clar	2
3	1TS	3			
1	1N	1			
25	M.Clar	2	24	U.Clar	2
23	Summer	2			
22	Cordova	1			
21	Dall	2			
20	Noyes	2			
13	Refuge	1			

## ROUTING OF STOCKS THROUGH FISHERY

1	Skeena						
4Z		11	10			1.000	
4Y		10	9			1.000	
4X		9	8	12	13	0.500	0.250 0.25
4W		8	6	5	3	0.150	0.850 0.000
Area 5		12	3			1.000	
3X		5	3	26		0.500	0.500
3Y		6	5	29		0.600	0.400
Fox		29	26			1.000	
L.Clar		26	3	22	25	0.300	0.550 0.150
1TS		3	21	1	13	0.050	0.500 0.450
Cordova		22	21	20		0.950	0.050
Dall		21	20			1.000	
M.Clar		25	24			1.000	
U.Clar		24	23			1.000	
2	Nass						
3Z-7		7	6			1.000	
3Y+7		6	29	5	8	0.220	0.280 0.500
4W		8	9	5		0.650	0.350
4X		9	12	13		0.150	0.850
Area 5		12	3			1.000	
3X		5	3	26		0.500	0.500
Fox		29	26			1.000	
L.Clar		26	3	22	25	0.300	0.570 0.130
M.Clar		25	24			1.000	
U.Clar		24	23			1.000	
Cordova		22	21	20		0.700	0.300
Dall		21	20			1.000	
1TS		3	21	1	13	0.180	0.82 0.000

## Appendix B - 1982 Sockeye Migration Routing Parameters

B-2

3 Stikine						
Term108	32	24	23		0.200	0.800
U.Clar	24	23			1.000	
4 US MacD						
Term101	30	26			1.000	
L.Clar	26	25	22	29	0.250	0.400 0.350
Tree	29	5	6		0.187	0.813
3Y+7	6	5			1.000	
3X	5	3			1.000	
1TS	3	1			1.000	
Cordova	22	21			1.000	
Dall	21	20			1.000	
M.Clar	25	24			1.000	
U.Clar	24	23			1.000	
5 US Other						
Stock	99	27	25	24	0.647	0.256 0.097
Revilla	27	26	29		0.650	0.350
L.Clar	26	22			1.000	
M.Clar	25	26	24		0.300	0.700
U.Clar	24	23			1.000	
Cordova	22	21			1.000	
Dall	21	20			1.000	
Tree	29	5	6	26	0.100	0.400 0.500
3Y+7	6	5	8		0.400	0.600
4W	8	5	9		0.900	0.100
4X	9	12			1.000	
3X	5	3			1.000	
1TS	3	1			1.000	

## Appendix B - 1983 Sockeye Migration Routing Parameters

B-3

## SOCKEYE FISHERIES ORDER

Fishery Order			Simultaneous		
Code	Label	Resid	Code	Label	Resid
32	Term108	1			
27	Revilla	2			
30	Term101	2			
12	Area 5	1			
11	4Z	2			
10	4Y	1			
9	4X	1			
8	4W	1			
7	3Z-7	2			
6	3Y+7	3			
5	3X	1			
29	Fox	1	26	L.Clar	2
3	1TS	3			
1	1N	1			
25	M.Clar	2	24	U.Clar	2
23	Sumner	2			
22	Cordova	1			
21	Dall	2			
20	Noyes	2			
13	Refuge	1			

## ROUTING OF STOCKS THROUGH FISHERY

1	Skeena						
4Z		11	10			1.000	
4Y		10	9			1.000	
4X		9	8	12	13	0.510	0.280 0.210
4W		8	6	5	3	0.255	0.745 0.000
Area 5		12	3			1.000	
3X		5	3	26		0.500	0.500
3Y		6	5	29		0.750	0.250
Fox		29	26			1.000	
L.Clar		26	3	22	25	0.100	0.770 0.130
1TS		3	21	1	13	0.500	0.500 0.000
Cordova		22	21	20		0.000	1.000
Dall		21	20			1.000	
M.Clar		25	24			1.000	
U.Clar		24	23			1.000	
2	Nass						
3Z-7		7	6			1.000	
3Y+7		6	29	5	8	0.210	0.250 0.540
4W		8	9	5		0.800	0.200
4X		9	12	13		0.950	0.050
Area 5		12	3			1.000	
3X		5	3	26		0.050	0.950
Fox		29	26			1.000	
L.Clar		26	3	22	25	0.000	0.840 0.160
M.Clar		25	24			1.000	
U.Clar		24	23			1.000	
Cordova		22	21	20		1.000	0.000
Dall		21	20			1.000	
1TS		3	21	1	13	0.180	0.82 0.000



## Appendix B - 1983 Sockeye Migration Routing Parameters

B-4

3 Stikine						
Term108	32	24	23		0.200	0.800
U.Clar	24	23			1.000	
4 US MacD						
Term101	30	26			1.000	
L.Clar	26	25	22	29	0.420	0.550 0.030
Tree	29	5	6		0.200	0.800
3Y+7	6	5			1.000	
3X	5	3			1.000	
1TS	3	1			1.000	
Cordova	22	21	20	13	0.200	0.300 0.500
Dall	21	20			1.000	
M.Clar	25	24			1.000	
U.Clar	24	23			1.000	
5 US Other						
Stock	99	27	25	24	0.100	0.480 0.420
Revilla	27	26	29		0.650	0.350
L.Clar	26	22			1.000	
M.Clar	25	26	24		0.750	0.250
U.Clar	24	23			1.000	
Cordova	22	21	20	13	0.200	0.300 0.500
Dall	21	20			1.000	
Tree	29	5	6	26	0.050	0.200 0.750
3Y+7	6	5	8		0.100	0.900
4W	8	5	9		0.100	0.900
4X	9	12			1.000	
3X	5	3			1.000	
1TS	3	1			1.000	

**Appendix C.**  
**Sockeye Migration Routing Diagrams.**

## Appendix C

### Sockeye Migration Routing Diagrams

These routing diagrams are provided to display the parameters that define the migration patterns for each stock. The migration patterns are constructed by working backward through the fisheries from the river mouth to the first interception fisheries. In the Skeena sockeye migration routing for 1982 (shown on the following page), 100% of Skeena sockeye migrate through the Area 4z, 4y and 4x fisheries. Outside these terminal fisheries the run divides into sub-stocks, with 50% migrating through Area 4w, 25% through Area 5 and 25% are not vulnerable to any interception fishery. Of the fish that migrate through Area 4w, 15% migrated through the Area 3y+7 fishery and 85% migrated through the Area 3x fishery. This process is repeated until each fishery that intercepts Skeena sockeye has been linked to the terminal fisheries for that stock. The numbers on each migration path indicate the percent of the fish in a specific fishery that migrated through adjacent fisheries, and these numbers must sum to 100% for the migration routes entering each fishery. The resulting portions of the total Skeena sockeye stock that migrate through each fishery are presented in Table 7 along with the proportions for other sockeye stocks. Similar information for pink salmon stocks are presented in Appendix G and Table 17.

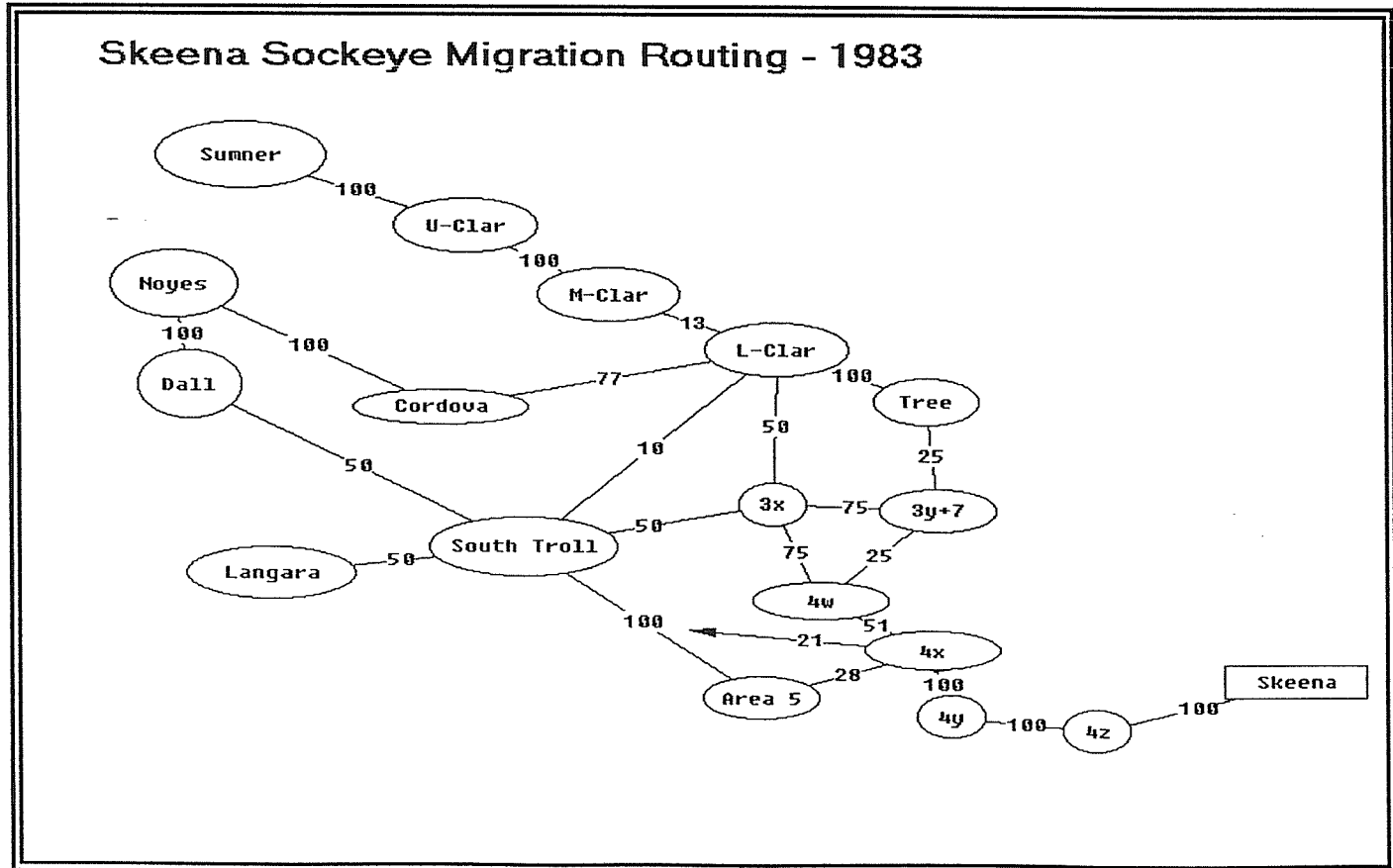
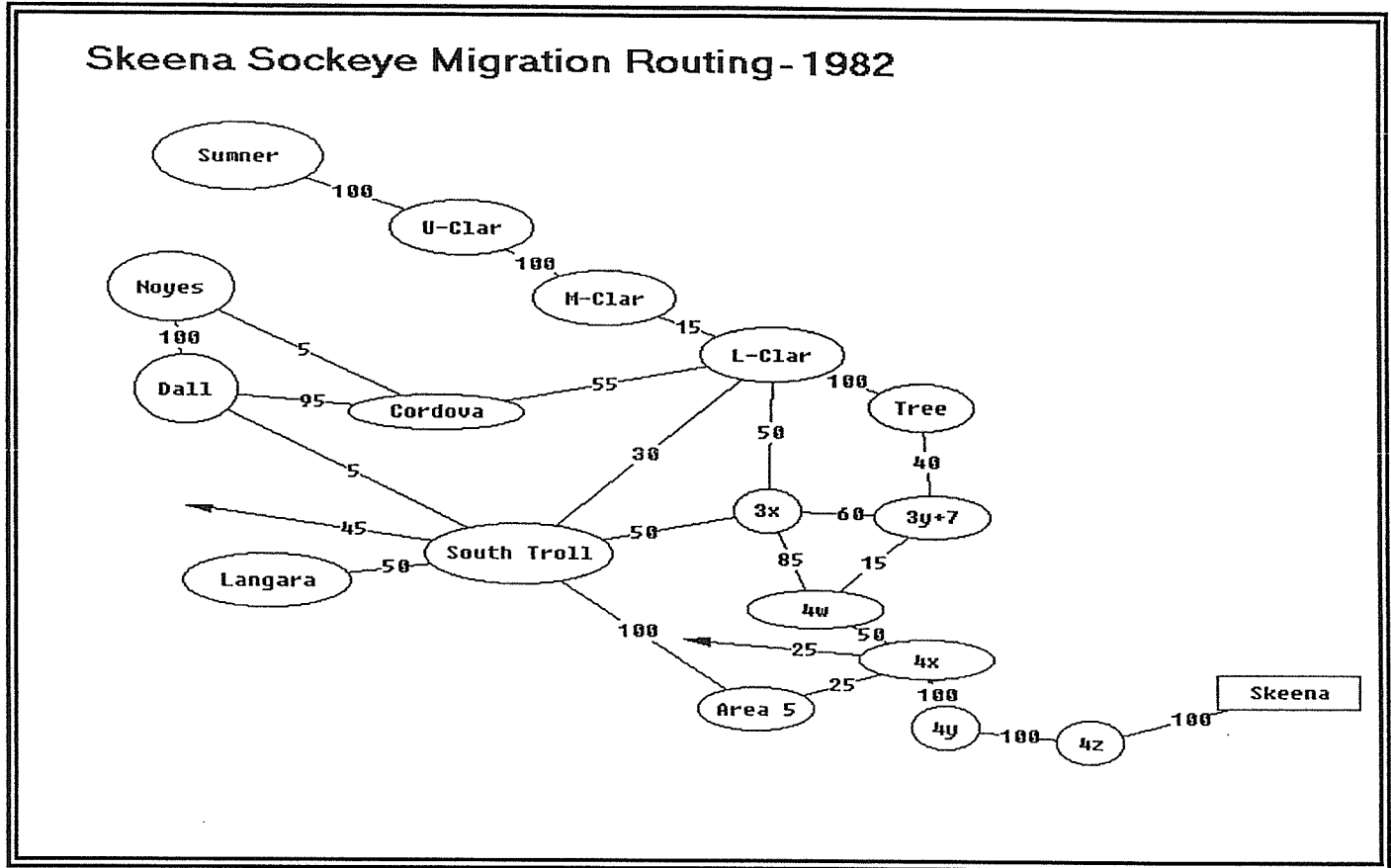

### Nass Sockeye Migration Routing - 1982

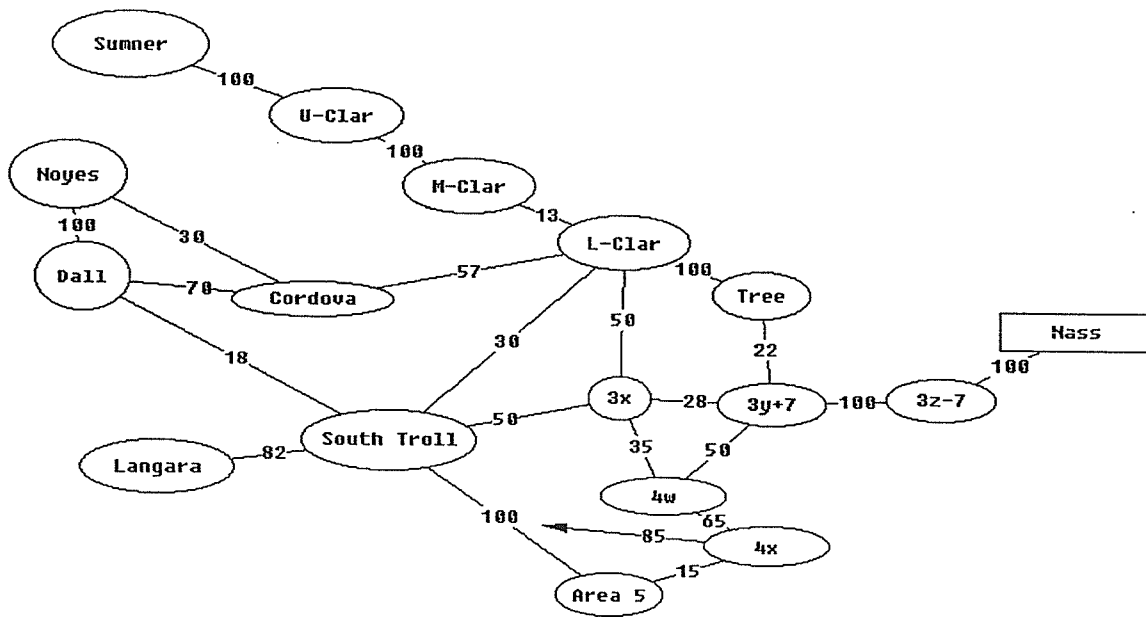

### Nass Sockeye Migration Routing - 1983

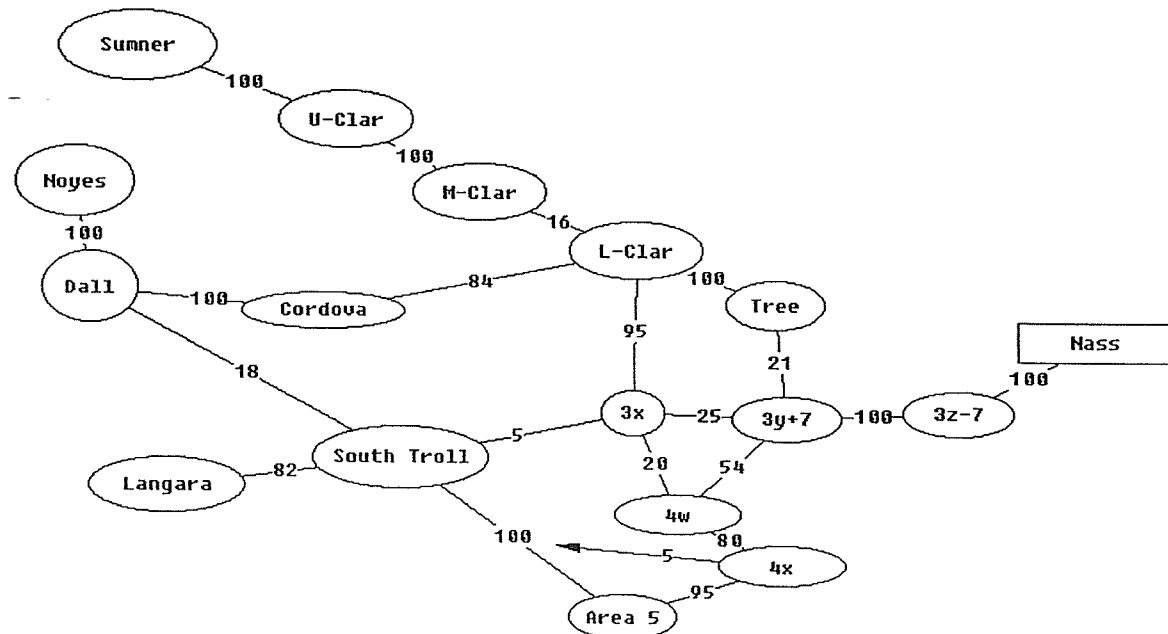

### Stikine Sockeye Migration Routing - 1982

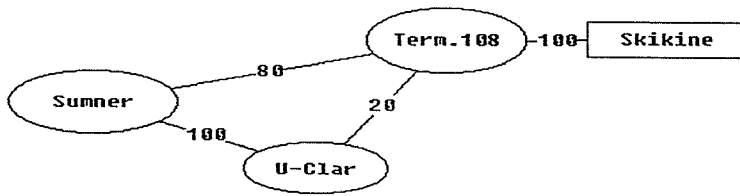

### Stikine Sockeye Migration Routing - 1983

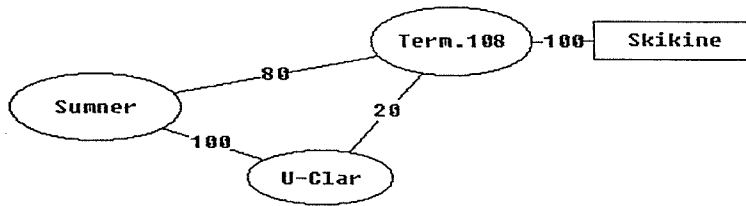

MacDonald Lake Sockeye Migration Routing - 1982

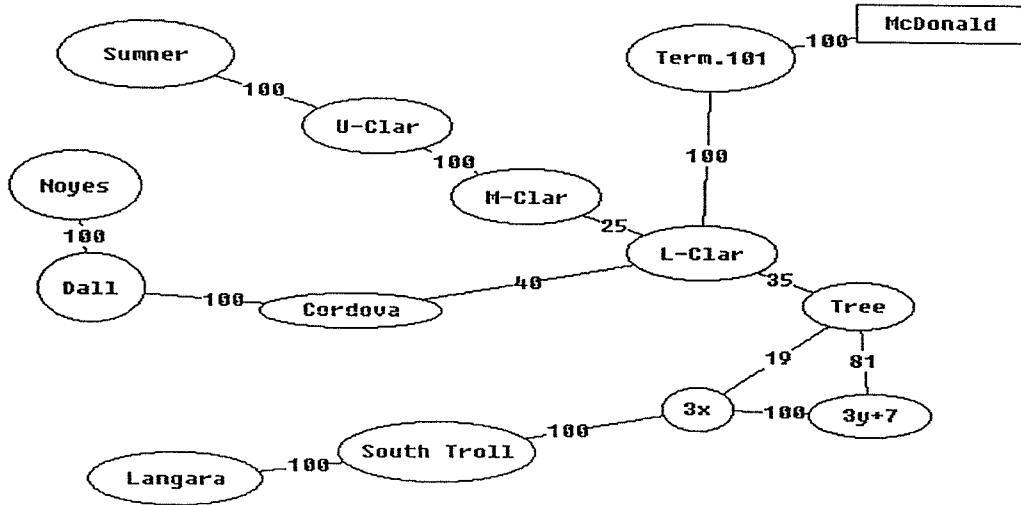

MacDonald Lake Sockeye Migration Routing - 1983

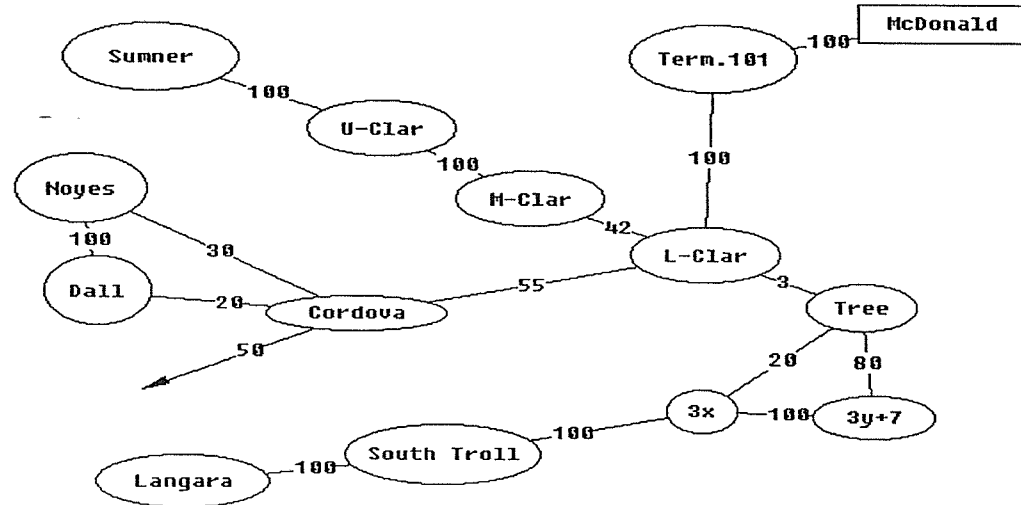

Other Alaskan Sockeye Migration Routing - 1982

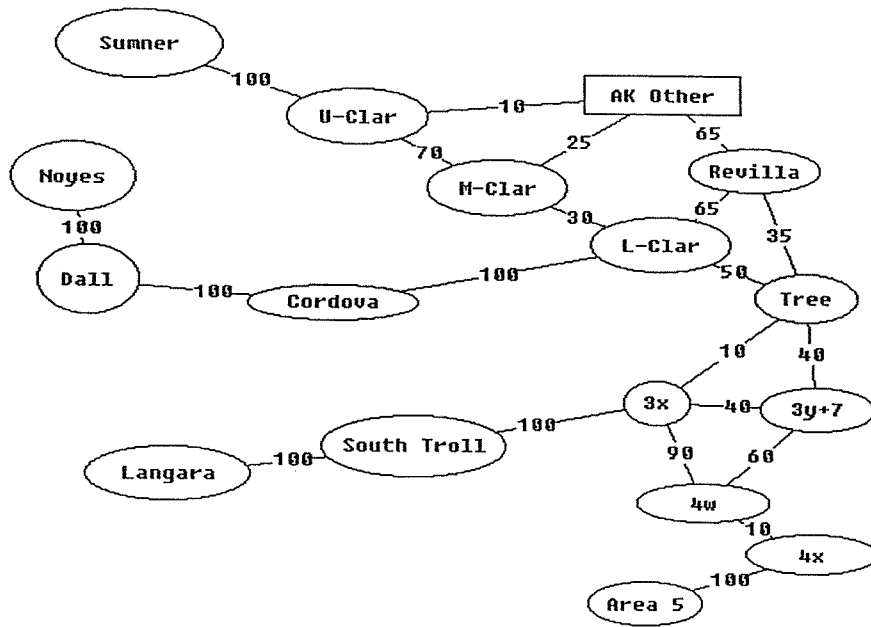

Other Alaskan Sockeye Migration Routing - 1983

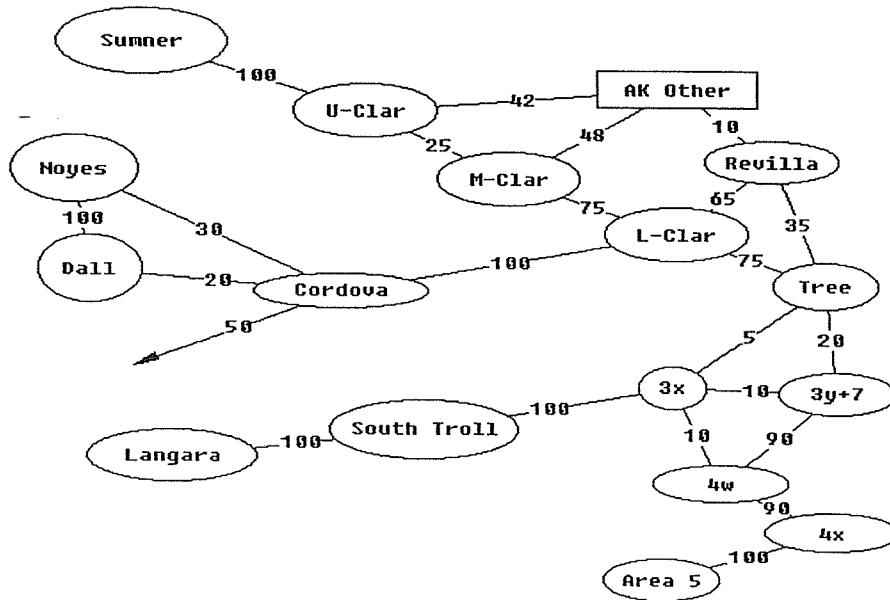



**Appendix D.**

**Sockeye Catch by Stock, 1982-95.**

Appendix D.1 1982 Sockeye catch by stock.

Fishery	Equal Vulnerability					Available Scale Data								
	Skeena	Nass	Stikine	US MacD	US Other	Fraser	Total	Skeena	Nass	Stikine	US MacD	US Other	Fraser	Total
Langara	42451	5294	0	1138	2122	7706	58712	42288	5246	0	1238	2234	7706	58712
ITS	1236	174	0	72	94	2274	3849	1238	175	0	71	91	2274	3849
3X	244713	39283	0	9082	18484	0	311561	244173	39182	0	9701	18505	0	311561
3Y+7	63272	58661	0	9841	10572	0	142346	62888	58600	0	9914	10944	0	142346
3Z-7	0	192373	0	0	0	0	192373	0	192373	0	0	0	0	192373
4W	670711	101157	0	0	16644	0	788512	669620	100961	0	0	17931	0	788511
4X	287788	48525	0	0	1169	0	337482	287787	48504	0	0	1191	0	337482
4Y	0	0	0	0	0	0	0	0	0	0	0	0	0	0
4Z	496593	0	0	0	0	0	496593	496593	0	0	0	0	0	496593
Area_5	65156	4292	0	0	740	0	70189	65103	4279	0	0	807	0	70189
Noyes	128512	15646	0	13111	33896	0	191165	104848	12407	0	12305	59447	0	189006
Dall	64818	8599	0	2369	15456	0	91241	49740	6569	0	3429	31435	0	91173
Cordova	199	0	0	210	98	0	506	53	0	0	308	138	0	499
Summer	50226	13469	26486	4156	27209	0	121546	29770	9891	20783	7841	51804	0	120089
U_Clar	42728	7134	3466	2343	16463	0	72134	18242	3785	14448	4387	30429	0	71292
M_Clar	0	0	0	0	0	0	0	0	0	0	0	0	0	0
L_Clar	33910	8106	0	6303	11277	0	59597	21377	4839	0	9228	24016	0	59460
Revilla	0	0	0	0	29061	0	29061	0	0	0	0	29065	0	29065
Fox	79952	53423	0	13925	43184	0	190484	74276	46833	0	15758	53588	0	190455
Term101	0	0	0	792	0	0	792	0	0	0	792	0	0	792
Term108	0	0	6746	0	0	0	6746	0	0	6746	0	0	0	6746
Total Catch	2272264	556136	36698	63342	226470	9980	3164889	2167996	533645	41977	74971	331624	9980	3160193
Escapement	1302823	340120	68761	56945	297055	0	2065704	1302823	340120	68761	56945	297055	0	2065704
Total Run	3575087	896256	105459	120287	523525	9980	5220613	3470819	873765	110738	131916	628679	9980	5215917
Expl Rate	63.6	62.1	34.8	52.7	43.3	0.0	60.4	62.5	61.1	37.9	56.8	52.8	0.0	60.4

## Appendix D.2 1983 Sockeye catch by stock.

Fishery	Equal Vulnerability					Available Scale Data								
	Skeena	Nass	Sitkine	US MacD	US Other	Fraser	Total	Skeena	Nass	Sitkine	US MacD	US Other	Fraser	Total
Langara	14617	3854	0	992	380	12588	32430	14495	3870	0	1023	453	12588	32430
1TS	1613	242	0	377	17	1609	3857	1645	241	0	344	18	1609	3857
3X	80947	13438	0	932	617	0	95934	80681	13427	0	1055	771	0	95934
3Y+7	172007	120095	0	4275	9015	0	305392	169358	119151	0	5135	11748	0	305392
3Z-7	0	44555	0	0	0	0	44555	0	44555	0	0	0	0	44555
4W	89169	23229	0	0	2926	0	115324	88805	23461	0	0	3058	0	115324
4X	45340	3403	0	0	527	0	49270	45335	3436	0	0	498	0	49270
4Y	0	0	0	0	0	0	0	0	0	0	0	0	0	0
4Z	119386	0	0	0	0	0	119386	119386	0	0	0	0	0	119386
Area_5	11212	2754	0	0	392	0	14359	11178	2741	0	0	439	0	14359
Noyes	263399	61381	0	15742	33002	136324	509847	219374	44056	0	26692	83401	136324	509847
Dall	60617	29851	0	1924	7885	40472	140749	48474	20926	0	4849	26029	40472	140750
Cordova	574	0	0	227	346	0	1147	397	0	0	339	411	0	1147
Sumner	5736	3621	6480	2160	9934	0	27931	3517	2164	3330	3512	15142	0	27667
U_Clar	5485	2838	894	2289	11382	0	22888	3692	1661	1796	2693	12639	0	22481
M_Clar	621	0	0	2044	1730	0	4396	1867	0	0	1347	1182	0	4396
L_Clar	18488	7288	0	4929	6684	0	37389	16165	5603	0	5279	10342	0	37389
Revilla	0	0	0	0	16190	0	16190	0	0	0	0	16190	0	16190
Fox	52895	58782	0	4737	19466	0	135879	43288	43217	0	8179	40707	0	135391
Term101	0	0	0	0	0	0	0	0	0	0	0	0	0	0
Term108	0	0	0	0	0	0	0	0	0	0	0	0	0	0
Total Catch	942106	375331	7374	40626	120492	190993	1676922	867658	328510	5126	60448	223028	190993	1675763
Escapement	1011521	208999	71683	56142	267858	0	1616203	1011521	208999	71683	56142	267858	0	1616203
Total Run	1953627	584330	79057	96768	388350	190993	3102132	1879179	537509	76809	116590	490886	190993	3100973
Expl Rate	48.2	64.2	9.3	42.0	31.0	0.0	47.9	46.2	61.1	6.7	51.9	45.4	0.0	47.9

## Appendix D.3 1984 Sockeye catch by stock.

Fishery	Equal Vulnerability					Available Scale Data								
	Skeena	Nass	Stikine	US MacD	US Other	Fraser	Total	Skeena	Nass	Stikine	US MacD	US Other	Fraser	Total
Langara	74	30	0	1	0	28393	28498	73	30	0	1	1	28393	28498
ITS	27	5	0	6	0	17854	17893	27	5	0	6	0	17854	17893
3X	107159	10342	0	2307	647	0	120455	106557	10322	0	2814	762	0	120455
3Y+7	41566	28989	0	2475	1872	0	74901	39687	29900	0	2920	2395	0	74901
3Z-7	0	74585	0	0	0	0	74585	0	74585	0	0	0	0	74585
4W	161410	30817	0	0	1816	0	194044	160917	30707	0	0	2420	0	194044
4X	100753	18836	0	0	2115	0	121705	100426	18777	0	0	2501	0	121705
4Y	157849	0	0	0	0	0	157849	157849	0	0	0	0	0	157849
4Z	262926	0	0	0	0	0	262926	262926	0	0	0	0	0	262926
Area_5	28782	6124	0	0	537	0	35443	28724	6072	0	0	647	0	35443
Noyes	115080	18801	0	10102	18655	0	162637	93622	25526	0	13041	30469	0	162658
Dall	84383	31386	0	6406	11454	0	133629	77075	21354	0	10757	24441	0	133627
Cordova	486	0	0	626	29	0	1141	144	0	0	941	55	0	1141
Summer	4885	1254	1962	3547	15724	0	27371	2472	5059	629	3395	15482	0	27038
U_Clar	14250	4220	2141	9570	35664	0	65845	6567	10670	3034	9660	34824	0	64755
M_Clar	174	0	0	1146	266	0	1586	704	0	0	704	177	0	1586
L_Clar	29230	8019	0	13550	14568	0	65366	13513	10724	0	15358	22891	0	62486
Revilla	0	0	0	0	33527	0	33527	0	0	0	0	33527	0	33527
Fox	38340	33920	0	5296	10592	0	88148	8364	43989	0	10244	23587	0	86184
Term101	0	0	0	2507	0	0	2507	0	0	0	2507	0	0	2507
Term108	0	0	1132	0	0	0	1132	0	0	1132	0	0	0	1132
Total Catch	1147373	267329	5234	57538	147466	46247	1671187	1059649	287719	4795	72350	194179	46247	1664939
Escapement	1220263	220954	76211	124093	420876	0	2062397	1220263	220954	76211	124093	420876	0	2062397
Total Run	2367636	488283	81445	181631	568342	46247	3687337	2279912	508673	81006	196443	615055	46247	3681089
Expl Rate	48.5	54.8	6.4	31.7	26.0	0.0	44.1	46.5	56.6	5.9	36.8	31.6	0.0	44.0

## Appendix D.4 1985 Sockeye catch by stock.

Fishery	Equal Vulnerability						Available Scale Data						
	Skeena	Nass	Sfikine	US MacD	US Other	Total	Skeena	Nass	Sfikine	US MacD	US Other	Fraser	Total
Langara	63138	6815	0	710	343	109213	63269	6818	0	609	309	38207	109213
1TS	12291	732	0	89	32	32736	12291	731	0	89	32	19593	32736
3X	219830	12871	0	669	494	233864	219855	12869	0	664	477	0	233864
3Y+7	86142	28829	0	1975	1944	118889	86292	28753	0	1905	1938	0	118889
3Z-7	0	55610	0	0	0	55610	0	55610	0	0	0	0	55610
4W	530899	60526	0	0	4698	596123	531607	60534	0	0	3982	0	596123
4X	371851	34601	0	0	1878	408330	371801	34601	0	0	1929	0	408330
4Y	395308	0	0	0	0	395308	395308	0	0	0	0	0	395308
4Z	633901	0	0	0	0	633901	633901	0	0	0	0	0	633901
Area_5	41900	11713	0	0	898	54510	41993	11741	0	0	776	0	54510
Noyes	259967	8561	0	15940	15760	308963	229553	6876	0	23569	40203	8736	308937
Dall	113414	16151	0	3230	4669	138991	93005	12655	0	8802	23001	1527	138991
Cordova	5057	0	0	2716	1840	9612	1571	0	0	5017	3020	0	9609
Summer	51467	11562	39012	17234	52814	172090	59240	9216	20293	23457	59556	0	171762
U_Clar	31220	8358	6046	13035	35117	93776	34208	6606	9037	11804	31669	0	93325
M_Clar	223	0	0	1316	0	1539	359	0	0	1180	0	0	1539
L_Clar	60450	4787	0	16041	8901	90178	30253	3203	0	28923	27781	0	90160
Revilla	0	0	0	0	43433	43433	0	0	0	0	43433	0	43433
Fox	97629	49906	0	6414	18797	172746	95854	46411	0	6327	23509	0	172102
Term101	0	0	0	18260	0	18260	0	0	0	18260	0	0	18260
Term108	0	0	551	0	0	551	0	0	551	0	0	0	551
Total Catch	2974686	311020	45610	97629	191616	3688623	2900361	296625	29881	130608	261615	68063	3687153
Escapement	2354163	398142	184747	120848	396140	3454040	2354163	398142	184747	120848	396140	0	3454040
Total Run	5328849	709162	230357	218477	587756	7074600	5254524	694767	214628	251456	657755	68063	7073130
Expl Rate	55.8	43.9	19.8	44.7	32.6	51.2	55.2	42.7	13.9	51.9	39.8	0.0	51.2

Appendix D.5 1986 Sockeye catch by stock

Fishery	Equal Vulnerability					Available Scale Data								
	Skeena	Nass	Sitkine	US MacD	US Other	Fraser	Total	Skeena	Nass	Sitkine	US MacD	US Other	Fraser	Total
Langara	22157	3895	0	983	340	4742	32117	22577	3915	0	659	225	4742	32117
ITS	13276	1065	0	1473	48	5559	21421	13551	1081	0	1184	46	5559	21421
3X	38962	8060	0	470	413	0	47904	39167	8057	0	385	295	0	47904
3Y+7	61682	51031	0	5032	3527	0	121272	53168	62017	0	3796	2291	0	121272
3Z-7	0	26697	0	0	0	0	26697	0	26697	0	0	0	0	26697
4W	47892	13837	0	0	847	0	62576	48032	13832	0	0	712	0	62576
4X	85694	7871	0	0	712	0	94277	85846	7859	0	0	572	0	94277
4Y	117068	0	0	0	0	0	117068	117068	0	0	0	0	0	117068
4Z	186271	0	0	0	0	0	186271	186271	0	0	0	0	0	186271
Area_5	24110	6205	0	0	676	0	30991	24191	6283	0	0	517	0	30991
Noyes	162794	31180	0	12902	23404	11265	241545	119005	58769	0	18321	33605	11265	240965
Dall	138199	41957	0	7903	15377	6742	210177	105622	52340	0	14486	30998	6742	210189
Cordova	2571	536	0	2455	326	0	5888	1157	328	0	3703	546	0	5734
Sumner	12148	7200	9859	15380	40638	0	85224	16265	8895	1778	15745	42193	0	84877
U_Clar	10205	4284	1947	12267	32695	0	61397	12443	5113	789	10868	31800	0	61014
M_Clar	336	97	0	1321	1020	0	2774	275	286	0	1123	910	0	2594
L_Clar	22091	8105	0	9995	9907	0	50098	5501	5992	0	15804	21330	0	48628
Revilla	0	0	0	0	38627	0	38627	0	0	0	0	38627	0	38627
Fox	59655	60286	0	5145	20515	0	145601	24499	107505	0	2834	9808	0	144645
Term101	0	0	0	11536	0	0	11536	0	0	0	11536	0	0	11536
Term108	0	0	3945	0	0	0	3945	0	0	3945	0	0	0	3945
Total Catch	1005110	272305	15751	86862	189071	28308	1597407	874639	368971	6512	100445	214473	28308	1593348
Escapement	840759	236251	69036	108217	339249	0	1593512	840759	236251	69036	108217	339249	0	1593512
Total Run	1845869	508556	84787	195079	528320	28308	3162611	1715398	605222	75548	208662	553722	28308	3158552
Expl Rate	54.5	53.5	18.6	44.5	35.8	0.0	49.6	51.0	61.0	8.6	48.1	38.7	0.0	49.6

Appendix D.6 1987 Sockeye catch by stock

Fishery	Equal Vulnerability					Available Scale Data								
	Skeena	Nass	Stikine	US MacD	US Other	Fraser	Total	Skeena	Nass	Stikine	US MacD	US Other	Fraser	Total
Langara	23581	2616	0	952	180	7507	34835	23594	2598	0	952	184	7507	34835
ITS	26704	1591	0	1169	128	15870	45462	26874	1552	0	1049	116	15870	45461
3X	35549	3267	0	451	287	0	39554	35544	3264	0	451	295	0	39554
3Y+7	127524	72446	0	4075	6809	0	210854	115806	85718	0	3220	6110	0	210854
3Z-7	0	44387	0	0	0	0	44387	0	44387	0	0	0	0	44387
4W	79833	7936	0	0	1984	0	89753	80030	7866	0	0	1857	0	89753
4X	88605	4423	0	0	1230	0	94258	88588	4432	0	0	1238	0	94258
4Y	128276	0	0	0	0	0	128276	128276	0	0	0	0	0	128276
4Z	201866	0	0	0	0	0	201866	201866	0	0	0	0	0	201866
Area_5	31845	6460	0	0	1076	0	39381	32037	6482	0	0	862	0	39381
Noyes	68654	10951	0	2285	10580	0	92469	34781	20620	0	6511	30557	0	92469
Dall	55127	15100	0	2273	6021	0	78522	29645	17257	0	6842	24776	0	78521
Cordova	42	0	0	1392	0	0	1434	0	0	0	1401	0	0	1401
Summer	14239	5021	6238	7957	45714	0	79168	8107	4400	1572	9782	55292	0	79153
U_Clar	11139	3660	961	6138	35356	0	57253	5757	2957	801	7070	40652	0	57238
M_Clar	0	0	0	0	0	0	0	0	0	0	0	0	0	0
L_Clar	8122	1842	0	3293	4348	0	17606	1212	3291	0	4952	7510	0	16965
Revilla	0	0	0	0	43049	0	43049	0	0	0	0	43049	0	43049
Fox	47450	39485	0	4473	16088	0	107497	15460	66300	0	4727	20316	0	106804
Term101	0	0	0	0	0	0	0	0	0	0	0	0	0	0
Term108	0	0	1616	0	0	0	1616	0	0	1616	0	0	0	1616
Total Catch	948556	219184	8814	34459	172850	23377	1407240	827577	271126	3990	46955	232816	23377	1405841
Escapement	1435977	219207	39264	137575	525444	0	2357467	1435977	219207	39264	137575	525444	0	2357467
Total Run	2384533	438391	48079	172034	698294	23377	3741330	2263554	490333	43254	184530	758260	23377	3739931
Expl Rate	39.8	50.0	18.3	20.0	24.8	0.0	37.0	36.6	55.3	9.2	25.5	30.7	0.0	37.0

Appendix D.7 1988 Sockeye catch by stock.

Fishery	Equal Vulnerability					Available Scale Data								
	Skeena	Nass	Stikine	US MacD	US Other	Fraser	Total	Skeena	Nass	Stikine	US MacD	US Other	Fraser	Total
Langara	37646	980	0	117	81	2817	41641	37617	982	0	136	89	2817	41641
ITS	42685	1404	0	150	61	7607	51906	42668	1404	0	160	66	7607	51906
3X	165514	5890	0	298	350	0	172052	165413	5887	0	353	398	0	172052
3Y+7	93731	21308	0	640	969	0	116649	91130	23757	0	699	1064	0	116649
3Z-7	0	14554	0	0	0	0	14554	0	14554	0	0	0	0	14554
4W	184015	21816	0	0	1196	0	207027	183858	21799	0	0	1370	0	207027
4X	214626	10389	0	0	774	0	225790	214493	10369	0	0	928	0	225790
4Y	392503	0	0	0	0	0	392503	392503	0	0	0	0	0	392503
4Z	679310	0	0	0	0	0	679310	679310	0	0	0	0	0	679310
Area_5	34009	5694	0	0	612	0	40315	33908	5648	0	0	759	0	40315
Noyes	354197	9896	0	9286	14792	0	388171	301374	18111	0	16282	48513	0	384281
Dall	184782	11404	0	3211	4392	0	203790	150816	11808	0	9622	29730	0	201976
Cordova	856	0	0	848	0	0	1704	878	0	0	566	0	0	1443
Summer	22973	3156	6704	4242	20262	0	57338	5097	831	1189	9082	41138	0	57337
U_Clar	14974	1805	968	3331	14116	0	35193	3468	397	674	5709	24944	0	35192
M_Clar	0	0	0	0	0	0	0	0	0	0	0	0	0	0
L_Clar	15609	714	0	2699	1972	0	20994	5256	5057	0	4124	4900	0	19337
Revilla	0	0	0	0	25025	0	25025	0	0	0	0	25025	0	25025
Fox	77354	31275	0	1550	5921	0	116101	28297	72429	0	2865	11939	0	115529
Term101	0	0	0	0	0	0	0	0	0	0	0	0	0	0
Term108	0	0	1095	0	0	0	1095	0	0	1095	0	0	0	1095
Total Catch	2514785	140287	8767	26371	90524	10424	2791158	2336086	193032	2958	49598	190863	10424	2782962
Escapement	1526435	163263	41915	73048	230367	0	2035028	1526435	163263	41915	73048	230367	0	2035028
Total Run	4041220	303550	50682	99419	320891	10424	4815762	3862521	356295	44873	122646	421230	10424	4807566
Expl Rate	62.2	46.2	17.3	26.5	28.2	0.0	57.7	60.5	54.2	6.6	40.4	45.3	0.0	57.7



Appendix D.8 1989 Sockeye catch by stock.

Fishery	Equal Vulnerability						Available Scale Data								
	Skeena	Nass	Stikine	US	MacD	US Other	Fraser	Total	Skeena	Nass	Stikine	US	MacD	US Other	Fraser
Langara	8874	682	0	1281	0	381	75729	86947	8906	687	0	1259	366	75729	86947
1TS	18510	1203	0	586	0	200	93011	113510	18506	1206	0	600	185	93011	113509
3X	62378	4979	0	1622	584	584	0	69563	62235	4969	0	1715	644	0	69563
3Y+7	208334	108184	0	9149	12865	12865	0	338532	207756	108260	0	9887	12628	0	338532
3Z-7	0	33062	0	0	0	0	0	33062	0	33062	0	0	0	0	33062
4W	98688	17414	0	2743	0	2743	0	118845	98571	17395	0	0	2879	0	118845
4X	87232	5882	0	1264	0	1264	0	94378	87151	5865	0	0	1362	0	94378
4Y	145160	0	0	0	0	0	0	145160	145160	0	0	0	0	0	145160
4Z	264016	0	0	0	0	0	0	264016	264016	0	0	0	0	0	264016
Area_5	18444	3011	0	784	0	784	0	22239	18364	2985	0	0	890	0	22239
Noyes	139624	16370	0	8718	15266	15266	137254	317232	130531	16156	0	11960	21331	137254	317232
Dall	91225	31835	0	3515	11275	11275	53772	191622	83735	30106	0	5996	18002	53772	191612
Cordova	3963	691	0	1629	2209	2209	0	8492	301	38	0	3150	5002	0	8492
Sumner	29751	9950	19577	11755	36834	36834	0	107868	26374	7520	4155	15185	54406	0	107640
U_Clar	26933	7193	4486	12178	37625	37625	0	88415	22195	4777	1924	12997	46401	0	88293
M_Clar	678	0	0	1857	2010	2010	0	4545	1045	0	0	1614	1885	0	4545
L_Clar	48700	10134	0	11040	15323	15323	0	85197	50426	9839	0	9747	15198	0	85210
Revilla	0	0	0	78208	0	78208	0	78208	0	0	0	0	78208	0	78208
Fox	77956	39109	0	4031	23811	23811	0	144907	74265	36765	0	6370	27456	0	144856
Term101	0	0	0	1497	0	1497	0	1497	0	0	0	1497	0	0	1497
Term108	0	0	11729	0	0	0	0	11729	0	0	11729	0	0	0	11729
Total Catch	1330466	289700	35792	68859	241383	241383	359766	2325965	1299538	279632	17809	81979	286842	359766	2325566
Escapement	1260374	138606	75054	82210	262454	262454	0	1818698	1260374	138606	75054	82210	262454	0	1818698
Total Run	2590840	428306	110846	151069	503837	503837	359766	3784897	2559912	418238	92863	164189	549296	359766	3784498
Expl Rate	51.4	67.6	32.3	45.6	47.9	47.9	0.0	52.0	50.8	66.9	19.2	49.9	52.2	0.0	51.9

Appendix D.9 1990 Sockeye catch by stock.

Fishery	Equal Vulnerability					Available Scale Data								
	Skeena	Nass	Stikine	US MacD	US Other	Fraser	Total	Skeena	Nass	Stikine	US MacD	US Other	Fraser	Total
Langara	18011	1988	0	317	199	42036	62552	17984	1992	0	339	200	42036	62552
1TS	18081	195	0	1162	31	7686	27155	17623	196	0	1617	33	7686	27155
3X	41988	3302	0	599	220	0	46108	41973	3300	0	626	209	0	46108
3Y+7	110793	41192	0	4298	3905	0	160188	103654	48343	0	4616	3575	0	160188
3Z-7	0	9551	0	0	0	0	9551	0	9551	0	0	0	0	9551
4W	132115	10747	0	0	1399	0	144261	132223	10679	0	0	1359	0	144261
4X	96269	3678	0	0	442	0	100389	96306	3651	0	0	432	0	100389
4Y	268252	0	0	0	0	0	268252	268252	0	0	0	0	0	268252
4Z	309543	0	0	0	0	0	309543	309543	0	0	0	0	0	309543
Area_5	46177	4372	0	0	779	0	51329	46206	4384	0	0	739	0	51329
Noyes	254309	13199	0	17608	18161	181105	484383	205486	28951	0	34447	34398	181105	484387
Dall	193923	17698	0	8550	13234	89331	322737	147901	30862	0	22081	32563	89331	322738
Cordova	4966	257	0	1727	2060	0	9011	703	46	0	3406	4855	0	9010
Summer	24898	5899	14028	13521	46450	0	104797	24592	15726	2056	14675	47155	0	104204
U_Clar	21008	4687	1891	14233	40325	0	82144	20188	7458	1228	13306	38520	0	80701
M_Clar	755	0	0	4044	491	0	5289	1254	0	0	3601	434	0	5289
L_Clar	46635	3678	0	14148	12769	0	77229	22363	15257	0	19019	20030	0	76668
Revilla	0	0	0	0	25194	0	25194	0	0	0	0	25194	0	25194
Fox	46945	24020	0	4939	9748	0	85651	25397	46087	0	6183	7849	0	85516
Term101	0	0	0	0	0	0	0	0	0	0	0	0	0	0
Term108	0	0	11021	0	0	0	11021	0	0	11021	0	0	0	11021
Total Catch	1634667	144464	26940	85145	175409	320158	2386784	1481647	226483	14306	123917	217546	320158	2384056
Escapement	1145020	178548	57386	120058	351330	0	1852342	1145020	178548	57386	120058	351330	0	1852342
Total Run	2779687	323012	84326	205203	526739	320158	3918968	2626667	405031	71692	243975	568876	320158	3916240
Expl Rate	58.8	44.7	32.0	41.5	33.3	0.0	52.7	56.4	55.9	20.0	50.8	38.2	0.0	52.7

## Appendix D.10 1991 Sockeye catch by stock.

Fishery	Equal Vulnerability						Available Scale Data						
	Skeena	Nass	Stikine	US MacD	US Other	Total	Skeena	Nass	Stikine	US MacD	US Other	Total	
Langara	17520	5044	0	1442	635	57035	18436	5009	0	824	372	32394	57035
1TS	27818	1302	0	1315	41	32291	27949	1305	0	1192	31	1815	32291
3X	245316	35529	0	4891	2140	287876	247753	35680	0	3048	1396	0	287876
3Y+7	257398	209127	0	12895	17542	496963	268459	210854	0	8097	9553	0	496963
3Z-7	0	98879	0	0	0	98879	0	98879	0	0	0	0	98879
4W	170430	40315	0	0	4357	215102	171941	40365	0	0	2796	0	215102
4X	122681	12597	0	0	1426	136704	123055	12610	0	0	1038	0	136704
4Y	285167	0	0	0	0	285167	285167	0	0	0	0	0	285167
4Z	351895	0	0	0	0	351895	351895	0	0	0	0	0	351895
Area_5	33932	10598	0	0	977	45507	34113	10663	0	0	730	0	45507
Noyes	297604	55503	0	44323	45283	482048	287970	50110	0	51514	47654	39336	476585
Dall	223542	89250	0	14375	29860	381581	240792	46912	0	24852	43614	24554	380723
Cordova	2102	627	0	1047	1290	5066	362	67	0	1823	2807	0	5066
Summer	18221	11312	18106	11112	30548	89299	6883	20697	12248	12519	34108	0	86455
U_Clar	12689	6772	2453	8696	25752	56361	4752	12242	4903	8000	24644	0	54541
M_Clar	130	0	0	411	155	696	170	0	0	381	146	0	696
L_Clar	30809	9115	0	8030	11136	59089	10155	12098	0	12506	24094	0	58853
Revilla	0	0	0	0	36597	36597	0	0	0	0	36595	0	36595
Fox	51084	50666	0	6388	23323	131462	52902	64760	0	4642	8957	0	131262
Term101	0	0	0	7954	0	7954	0	0	0	7954	0	0	7954
Term108	0	0	24340	0	0	24340	0	0	24340	0	0	0	24340
Total Catch	2148338	636639	44898	122877	231059	3281910	2132754	622252	41490	137351	238536	98099	3270483
Escapement	1371650	345431	120152	187838	564729	2589800	1371650	345431	120152	187838	564729	0	2589800
Total Run	3519988	982070	165050	310715	795789	5773612	3504404	967683	161642	325189	803265	98099	5762184
Expl Rate	61.0	64.8	27.2	39.6	29.0	55.1	60.9	64.3	25.7	42.2	29.7	0.0	55.1

Appendix D.11 1992 Sockeye catch by stock.

Fishery	Equal Vulnerability					Available Scale Data								
	Skeena	Nass	Stikine	US MacD	US Other	Fraser	Total	Skeena	Nass	Stikine	US MacD	US Other	Fraser	Total
Langara	28111	12375	0	1037	368	44475	86365	27940	12410	0	1187	353	44475	86365
ITS	8344	1764	0	946	27	5180	16261	8314	1764	0	974	29	5180	16261
3X	161775	33416	0	1002	855	0	197048	161461	33334	0	1197	1055	0	197048
3Y+7	155881	244769	0	4763	6591	0	412004	146546	235501	0	5036	6920	0	412004
3Z-7	0	380925	0	0	0	0	380925	0	380925	0	0	0	0	380925
4W	363645	119519	0	0	6956	0	490120	363387	119549	0	0	7183	0	490120
4X	190112	42498	0	0	1970	0	234580	189993	42506	0	0	2081	0	234580
4Y	463175	0	0	0	0	0	463175	463175	0	0	0	0	0	463175
4Z	452178	0	0	0	0	0	452178	452178	0	0	0	0	0	452178
Area_5	40112	30486	0	0	1124	0	71722	40068	30473	0	0	1181	0	71722
Noyes	337760	166489	0	22457	45457	42930	615093	365933	98464	0	30400	74995	42930	612723
Dall	212486	171278	0	14443	20590	39579	458376	265021	68025	0	30861	52747	39579	456233
Cordova	822	812	0	1202	199	0	3034	170	173	0	2196	495	0	3034
Summer	26628	15658	31192	12792	60260	0	146531	18524	14525	23064	12991	73703	0	142807
U_Clar	12657	7915	3040	6045	26864	0	56522	7395	5308	7633	5442	28788	0	54566
M_Clar	408	337	0	2510	2483	0	5738	218	334	0	2555	2573	0	5680
L_Clar	24071	13156	0	7566	7351	0	52144	11053	6728	0	13820	20454	0	52055
Revilla	0	0	0	0	62821	0	62821	0	0	0	0	62822	0	62822
Fox	76950	137929	0	5296	24330	0	244505	26095	168197	0	8236	41721	0	244249
Term101	0	0	0	23001	0	0	23001	0	0	0	23001	0	0	23001
Term108	0	0	52819	0	0	0	52819	0	0	52819	0	0	0	52819
Total Catch	2555114	1379327	87052	103060	268245	132164	4524963	2547472	1236216	83516	137897	377102	132164	4514368
Escapement	1547394	687209	154542	145867	687258	0	3222270	1547394	687209	154542	145867	687258	0	3222270
Total Run	4102508	2066536	241594	248927	955503	132164	7615069	4094866	1923425	238058	283764	1064360	132164	7604474
Expl Rate	62.3	66.8	36.0	41.4	28.1	0.0	57.7	62.2	64.3	35.1	48.6	35.4	0.0	57.6

Appendix D.12 1993 Sockeye catch by stock.

Fishery	Equal Vulnerability					Available Scale Data					Total			
	Skeena	Nass	Sfikine	US MacD	US Other	Fraser	Total	Skeena	Nass	Sfikine		US MacD	US Other	Fraser
Langara	35160	23858	0	1427	520	160436	221400	35176	23904	0	1432	452	160436	221400
1TS	0	0	0	0	0	0	0	0	0	0	0	0	0	0
3X	202049	65542	0	2048	672	0	270310	202251	65506	0	1950	603	0	270310
3Y+7	213144	346842	0	7941	6844	0	574771	201043	360364	0	7361	6004	0	574771
3Z-7	0	504376	0	0	0	0	504376	0	504376	0	0	0	0	504376
4W	385804	192061	0	0	3700	0	581565	386188	191855	0	0	3522	0	581565
4X	233923	77739	0	0	1657	0	313319	234032	77647	0	0	1639	0	313319
4Y	268430	0	0	0	0	0	268430	268430	0	0	0	0	0	268430
4Z	509830	0	0	0	0	0	509830	509830	0	0	0	0	0	509830
Area_5	25848	15756	0	0	630	0	42234	25851	15791	0	0	591	0	42234
Noyes	177563	139433	0	44232	28322	109921	499471	213064	76735	0	47188	51330	109921	498238
Dall	172080	209340	0	13594	19178	72084	486275	208312	105581	0	29734	70360	72084	486071
Cordova	1347	2560	0	4962	372	0	9240	461	622	0	7438	717	0	9239
Summer	17320	17461	21956	22301	50648	0	129686	28410	14097	29734	15831	35625	0	123698
U_Clar	12270	10635	2771	14158	36106	0	75940	18110	8380	14408	8814	21930	0	71643
M_Clar	433	1139	0	3201	3179	0	7952	30	342	0	3678	3903	0	7952
L_Clar	83639	68283	0	27534	34971	0	214427	47129	56041	0	43907	67368	0	214445
Revilla	0	0	0	0	13218	0	13218	0	0	0	0	13218	0	13218
Fox	115290	238136	0	12581	27839	0	393846	44522	307011	0	16571	25541	0	393645
Term101	0	0	0	99386	0	0	99386	0	0	0	99390	0	0	99390
Term108	0	0	70301	0	0	0	70301	0	0	70301	0	0	0	70301
Total Catch	2454128	1913160	95028	253363	227857	342441	5285977	2422841	1808252	114443	283292	302804	342441	5274074
Escapement	1952256	584026	176100	242850	753124	0	3708356	1952256	584026	176100	242850	753124	0	3708356
Total Run	4406384	2497186	271128	496213	980981	342441	8651892	4375097	2392278	290543	526142	1055928	342441	8639989
Expl Rate	55.7	76.6	35.1	51.1	23.2	0.0	57.1	55.4	75.6	39.4	53.8	28.7	0.0	57.1

Appendix D.13 1994 Sockeye catch by stock.

Fishery	Equal Vulnerability					Available Scale Data								
	Skeena	Nass	Stikine	US MacD	US Other	Fraser	Total	Skeena	Nass	Stikine	US MacD	US Other	Fraser	Total
Langara	9974	6972	0	438	85	96316	113785	9848	6903	0	634	83	96316	113785
ITS	0	0	0	0	0	0	0	0	0	0	0	0	0	0
3X	64354	8099	0	342	214	0	73009	64338	8031	0	413	227	0	73009
3Y+7	94976	136585	0	1526	2259	0	235347	93258	138184	0	1648	2256	0	235347
3Z-7	0	39103	0	0	0	0	39103	0	39103	0	0	0	0	39103
4W	194041	40884	0	0	1924	0	236850	193905	40977	0	0	1968	0	236850
4X	93843	14294	0	0	589	0	108725	93822	14302	0	0	602	0	108725
4Y	115086	0	0	0	0	0	115086	115086	0	0	0	0	0	115086
4Z	190400	0	0	0	0	0	190400	190400	0	0	0	0	0	190400
Area_5	24915	10939	0	0	550	0	36404	24933	10962	0	0	508	0	36404
Noyes	283746	198745	0	40407	60952	186569	770419	348280	84579	0	51709	94042	186569	765180
Dall	103639	68478	0	3249	11982	183697	371045	104506	38493	0	9249	35100	183697	371045
Cordova	771	3233	0	4847	1119	0	9970	376	757	0	7071	1725	0	9930
Summer	22715	13103	51020	16518	54059	0	157415	17329	13637	37064	19190	67512	0	154732
U_Clar	10068	6968	4563	9373	24324	0	55295	7587	3994	9792	7731	23800	0	52903
M_Clar	160	658	0	2588	2976	0	6383	2843	120	0	1416	1439	0	5818
L_Clar	28675	13835	0	9331	10011	0	61852	15544	16294	0	10170	18996	0	61004
Revilla	0	0	0	0	15093	0	15093	0	0	0	0	15093	0	15093
Fox	30511	57769	0	3456	8563	0	100299	8991	75512	0	5855	9462	0	99819
Term101	0	0	0	115	0	0	115	0	0	0	115	0	0	115
Term108	0	0	98174	0	0	0	98174	0	0	98174	0	0	0	98174
Total Catch	1267874	619667	153756	92189	194701	466582	2794770	1291048	491847	145030	115200	272814	466582	2782520
Escapement	1205398	344647	127527	116929	372112	0	2166613	1205398	344647	127527	116929	372112	0	2166613
Total Run	2473272	964314	281283	209118	566813	466582	4494801	2496446	836494	272557	232129	644926	466582	4482552
Expl.Rate	51.3	64.3	54.7	44.1	34.4	0.0	51.8	51.7	58.8	53.2	49.6	42.3	0.0	51.7

## Appendix D.14 1995 Sockeye catch by stock.

Fishery	Equal Vulnerability						Available Scale Data									
	Skeena	Nass	Stikine	US	MacD	Other	Fraser	Total	Skeena	Nass	Stikine	US	MacD	Other	Fraser	Total
Langara	74358	24744	0	1148	835	3741	104826	74481	24719	0	1147	738	3741	104826		
1TS	0	0	0	0	0	0	0	0	0	0	0	0	0	0	0	0
3X	529914	62509	0	2115	1351	0	595889	528915	62582	0	2876	1517	0	595889		
3Y+7	456619	285903	0	3069	6502	0	752092	437287	304234	0	3958	6612	0	752091		
3Z-7	0	114953	0	0	0	0	114953	0	114953	0	0	0	0	114953		
4W	505293	81494	0	0	2598	0	589384	504891	81567	0	0	2926	0	589384		
4X	258101	30924	0	0	1037	0	290061	257909	30843	0	0	1309	0	290061		
4Y	360521	0	0	0	0	0	360521	360521	0	0	0	0	0	360521		
4Z	412258	0	0	0	0	0	412258	412258	0	0	0	0	0	412258		
Area_5	35773	13878	0	0	510	0	50161	35718	13848	0	0	594	0	50161		
Noyes	157377	60655	0	7915	6263	16682	248892	135573	50447	0	16983	20099	16682	239784		
Dall	133758	107384	0	4954	3345	6261	255702	141813	58935	0	21467	18811	6261	247286		
Cordova	1165	1101	0	381	150	0	2798	138	140	0	1889	631	0	2798		
Summer	49954	23192	26579	12653	20864	0	133242	57641	15694	14557	12884	28314	0	129091		
U_Clar	31912	15159	3152	11326	17621	0	79171	39330	7537	4103	7346	16145	0	74460		
M_Clar	6304	5337	0	7815	3834	0	23290	3605	2692	0	11182	5800	0	23279		
L_Clar	110017	52962	0	16236	11279	0	190494	98947	29779	0	25365	32236	0	186327		
Revilla	0	0	0	0	38927	0	38927	0	0	0	0	38927	0	38927		
Fox	91537	63877	0	1723	4701	0	163838	38162	111223	0	4477	8396	0	162258		
Term101	0	0	0	7432	0	0	7432	0	0	0	7432	0	0	7432		
Term108	0	0	76074	0	0	0	76074	0	0	76074	0	0	0	76074		
Total Catch	3214861	946072	105805	76768	119815	26684	4490005	3127191	909192	94734	117005	183054	26684	4457860		
Escapement	2063957	312290	142308	51629	162363	0	2732547	2063957	312290	142308	51629	162363	0	2732547		
Total Run	5278818	1258362	248113	128397	282178	26684	7195868	5191148	1221482	237042	168634	345417	26684	7163723		
Expl Rate	60.9	75.2	42.6	59.8	42.5	0.0	62.0	60.2	74.4	40.0	69.4	53.0	0.0	61.9		

**Appendix E.**

**Differences Between Two Alternative Sockeye Run Reconstructions, 1982-95.**



## Appendix E.1 1982 Sockeye catch by stock.

Fishery	Difference*						Total
	Skeena	Nass	Stikine	US MacD	US Other	Fraser	
Langara	163	48	0	-100	-112	0	0
ITS	-2	-1	0	1	3	0	0
3X	540	101	0	-619	-21	0	0
3Y+7	384	61	0	-73	-372	0	0
3Z-7	0	0	0	0	0	0	0
4W	1091	196	0	0	-1287	0	1
4X	1	21	0	0	-22	0	0
4Y	0	0	0	0	0	0	0
4Z	0	0	0	0	0	0	0
Area_5	53	13	0	0	-67	0	0
Noyes	23664	3239	0	806	-25551	0	2159
Dall	15078	2030	0	-1060	-15979	0	68
Cordova	146	0	0	-98	-40	0	7
Sumner	20456	3578	5703	-3685	-24595	0	1457
U_Clar	24486	3349	-10982	-2044	-13966	0	842
M_Clar	0	0	0	0	0	0	0
L_Clar	12533	3267	0	-2925	-12739	0	137
Revilla	0	0	0	0	-4	0	-4
Fox	5676	6590	0	-1833	-10404	0	29
Term101	0	0	0	0	0	0	0
Term108	0	0	0	0	0	0	0
Total Catch	104268	22491	-5279	-11629	-105154	0	4696
Escapement	0	0	0	0	0	0	0
Total Run	104268	22491	-5279	-11629	-105154	0	4696
Expl Rate	1.1	1.0	-3.1	-4.2	-9.5	0.0	0.0

\* Estimates based on equal vulnerability minus estimates derived using the available Alaska scale data.

## Appendix E.2 1983 Sockeye catch by stock.

Fishery	Difference*						Total
	Skeena	Nass	Stikine	US MacD	US Other	Fraser	
Langara	122	-16	0	-31	-73	0	0
1TS	-32	1	0	33	-1	0	0
3X	266	11	0	-123	-154	0	0
3Y+7	2649	944	0	-860	-2733	0	0
3Z-7	0	0	0	0	0	0	0
4W	364	-232	0	0	-132	0	0
4X	5	-33	0	0	29	0	0
4Y	0	0	0	0	0	0	0
4Z	0	0	0	0	0	0	0
Area_5	34	13	0	0	-47	0	0
Noyes	44025	17325	0	-10950	-50399	0	0
Dall	12143	8925	0	-2925	-18144	0	-1
Cordova	177	0	0	-112	-65	0	0
Sumner	2219	1457	3150	-1352	-5208	0	264
U_Clar	1793	1177	-902	-404	-1257	0	407
M_Clar	-1246	0	0	697	548	0	0
L_Clar	2323	1685	0	-350	-3658	0	0
Revilla	0	0	0	0	0	0	0
Fox	9607	15565	0	-3442	-21241	0	488
Term101	0	0	0	0	0	0	0
Term108	0	0	0	0	0	0	0
Total Catch	74448	46821	2248	-19822	-102536	0	1159
Escapement	0	0	0	0	0	0	0
Total Run	74448	46821	2248	-19822	-102536	0	1159
Expl Rate	2.1	3.1	2.7	-9.9	-14.4	0.0	0.0

\* Estimates based on equal vulnerability minus estimates derived using the available Alaska scale data.

## Appendix E.3 1984 Sockeye catch by stock.

Fishery	Difference*						Total
	Skeena	Nass	Stikine	US MacD	US Other	Fraser	
Langara	1	0	0	0	-1	0	0
ITS	0	0	0	0	0	0	0
3X	602	20	0	-507	-115	0	0
3Y+7	1879	-911	0	-445	-523	0	0
3Z-7	0	0	0	0	0	0	0
4W	493	110	0	0	-604	0	0
4X	327	59	0	0	-386	0	0
4Y	0	0	0	0	0	0	0
4Z	0	0	0	0	0	0	0
Area_5	58	52	0	0	-110	0	0
Noyes	21458	-6725	0	-2939	-11814	0	-21
Dall	7308	10032	0	-4351	-12987	0	2
Cordova	342	0	0	-315	-26	0	0
Sumner	2413	-3805	1333	152	242	0	333
U_Clar	7683	-6450	-893	-90	840	0	1090
M_Clar	-530	0	0	442	89	0	0
L_Clar	15717	-2705	0	-1808	-8323	0	2880
Revilla	0	0	0	0	0	0	0
Fox	29976	-10069	0	-4948	-12995	0	1964
Term101	0	0	0	0	0	0	0
Term108	0	0	0	0	0	0	0
Total Catch	87724	-20390	439	-14812	-46713	0	6248
Escapement	0	0	0	0	0	0	0
Total Run	87724	-20390	439	-14812	-46713	0	6248
Expl Rate	2.0	-1.8	0.5	-5.2	-5.6	0.0	0.1

\* Estimates based on equal vulnerability minus estimates derived using the available Alaska scale data.

## Appendix E.4 1985 Sockeye catch by stock.

Fishery	Difference*						Total
	Skeena	Nass	Stikine	US MacD	US Other	Fraser	
Langara	-131	-3	0	101	34	0	0
1TS	0	1	0	0	0	0	0
3X	-25	2	0	5	17	0	0
3Y+7	-150	76	0	70	6	0	0
3Z-7	0	0	0	0	0	0	0
4W	-708	-8	0	0	716	0	0
4X	50	0	0	0	-51	0	0
4Y	0	0	0	0	0	0	0
4Z	0	0	0	0	0	0	0
Area_5	-93	-28	0	0	122	0	0
Noyes	30414	1685	0	-7629	-24443	0	26
Dall	20409	3496	0	-5572	-18332	0	0
Cordova	3486	0	0	-2301	-1180	0	3
Sumner	-7773	2346	18719	-6223	-6742	0	328
U_Clar	-2988	1752	-2991	1231	3448	0	451
M_Clar	-136	0	0	136	0	0	0
L_Clar	30197	1584	0	-12882	-18880	0	18
Revilla	0	0	0	0	0	0	0
Fox	1775	3495	0	87	-4712	0	644
Term101	0	0	0	0	0	0	0
Term108	0	0	0	0	0	0	0
Total Catch	74325	14395	15729	-32979	-69999	0	1470
Escapement	0	0	0	0	0	0	0
Total Run	74325	14395	15729	-32979	-69999	0	1470
Expl Rate	0.6	1.2	5.9	-7.3	-7.2	0.0	0.0

\* Estimates based on equal vulnerability minus estimates derived using the available Alaska scale data.

## Appendix E.5 1986 Sockeye catch by stock.

Fishery	Difference*						Total
	Skeena	Nass	Stikine	US MacD	US Other	Fraser	
Langara	-420	-20	0	324	115	0	0
ITS	-275	-16	0	289	2	0	0
3X	-205	3	0	85	118	0	0
3Y+7	8514	-10986	0	1236	1236	0	0
3Z-7	0	0	0	0	0	0	0
4W	-140	5	0	0	135	0	0
4X	-152	12	0	0	140	0	0
4Y	0	0	0	0	0	0	0
4Z	0	0	0	0	0	0	0
Area_5	-81	-78	0	0	159	0	0
Noyes	43789	-27589	0	-5419	-10201	0	580
Dall	32577	-10383	0	-6583	-15621	0	-12
Cordova	1414	208	0	-1248	-220	0	154
Sumner	-4117	-1695	8081	-365	-1555	0	347
U_Clar	-2238	-829	1158	1399	895	0	383
M_Clar	61	-189	0	198	110	0	180
L_Clar	16590	2113	0	-5809	-11423	0	1470
Revilla	0	0	0	0	0	0	0
Fox	35156	-47219	0	2311	10707	0	956
Term101	0	0	0	0	0	0	0
Term108	0	0	0	0	0	0	0
Total Catch	130471	-96666	9239	-13583	-25402	0	4059
Escapement	0	0	0	0	0	0	0
Total Run	130471	-96666	9239	-13583	-25402	0	4059
Expl Rate	3.5	-7.4	10.0	-3.6	-2.9	0.0	0.1

\* Estimates based on equal vulnerability minus estimates derived using the available Alaska scale data.

## Appendix E.6 1987 Sockeye catch by stock.

Fishery	Difference*						Total
	Skeena	Nass	Stikine	US MacD	US Other	Fraser	
Langara	-13	18	0	0	-4	0	0
1TS	-170	39	0	120	12	0	1
3X	5	3	0	0	-8	0	0
3Y+7	11718	-13272	0	855	699	0	0
3Z-7	0	0	0	0	0	0	0
4W	-197	70	0	0	127	0	0
4X	17	-9	0	0	-8	0	0
4Y	0	0	0	0	0	0	0
4Z	0	0	0	0	0	0	0
Area_5	-192	-22	0	0	214	0	0
Noyes	33873	-9669	0	-4226	-19977	0	0
Dall	25482	-2157	0	-4569	-18755	0	1
Cordova	42	0	0	-9	0	0	33
Sumner	6132	621	4666	-1825	-9578	0	15
U_Clar	5382	703	160	-932	-5296	0	15
M_Clar	0	0	0	0	0	0	0
L_Clar	6910	-1449	0	-1659	-3162	0	641
Revilla	0	0	0	0	0	0	0
Fox	31990	-26815	0	-254	-4228	0	693
Term101	0	0	0	0	0	0	0
Term108	0	0	0	0	0	0	0
Total Catch	120979	-51942	4824	-12496	-59966	0	1399
Escapement	0	0	0	0	0	0	0
Total Run	120979	-51942	4825	-12496	-59966	0	1399
Expl Rate	3.2	-5.3	9.1	-5.4	-6.0	0.0	0.0

\* Estimates based on equal vulnerability minus estimates derived using the available Alaska scale data.

## Appendix E.7 1988 Sockeye catch by stock.

Fishery	Difference*						Total
	Skeena	Nass	Stikine	US MacD	US Other	Fraser	
Langara	29	-2	0	-19	-8	0	0
1TS	17	0	0	-10	-5	0	0
3X	101	3	0	-55	-48	0	0
3Y+7	2601	-2449	0	-59	-95	0	0
3Z-7	0	0	0	0	0	0	0
4W	157	17	0	0	-174	0	0
4X	133	20	0	0	-154	0	0
4Y	0	0	0	0	0	0	0
4Z	0	0	0	0	0	0	0
Area_5	101	46	0	0	-147	0	0
Noyes	52823	-8215	0	-6996	-33721	0	3890
Dall	33966	-404	0	-6411	-25338	0	1814
Cordova	-22	0	0	282	0	0	261
Sumner	17876	2325	5515	-4840	-20876	0	1
U_Clar	11506	1408	294	-2378	-10828	0	1
M_Clar	0	0	0	0	0	0	0
L_Clar	10353	-4343	0	-1425	-2928	0	1657
Revilla	0	0	0	0	0	0	0
Fox	49057	-41154	0	-1315	-6018	0	572
Term101	0	0	0	0	0	0	0
Term108	0	0	0	0	0	0	0
Total Catch	178699	-52745	5809	-23227	-100339	0	8196
Escapement	0	0	0	0	0	0	0
Total Run	178699	-52745	5809	-23227	-100339	0	8196
Expl Rate	1.8	-8.0	10.7	-13.9	-17.1	0.0	0.1

\* Estimates based on equal vulnerability minus estimates derived using the available Alaska scale data.

## Appendix E.8 1989 Sockeye catch by stock.

Fishery	Difference*						Total
	Skeena	Nass	Stikine	US MacD	US Other	Fraser	
Langara	-32	-5	0	22	15	0	0
ITS	4	-3	0	-14	15	0	1
3X	143	10	0	-93	-60	0	0
3Y+7	578	-76	0	-738	237	0	0
3Z-7	0	0	0	0	0	0	0
4W	117	19	0	0	-136	0	0
4X	81	17	0	0	-98	0	0
4Y	0	0	0	0	0	0	0
4Z	0	0	0	0	0	0	0
Area_5	80	26	0	0	-106	0	0
Noyes	9093	214	0	-3242	-6065	0	0
Dall	7490	1729	0	-2481	-6727	0	10
Cordova	3662	653	0	-1521	-2793	0	0
Sumner	3377	2430	15422	-3430	-17572	0	228
U_Clar	4738	2416	2562	-819	-8776	0	122
M_Clar	-367	0	0	243	125	0	0
L_Clar	-1726	295	0	1293	125	0	-13
Revilla	0	0	0	0	0	0	0
Fox	3691	2344	0	-2339	-3645	0	51
Term101	0	0	0	0	0	0	0
Term108	0	0	0	0	0	0	0
Total Catch	30928	10068	17983	-13120	-45459	0	399
Escapement	0	0	0	0	0	0	0
Total Run	30928	10068	17983	-13120	-45459	0	399
Expl Rate	0.6	0.8	13.1	-4.4	-4.3	0.0	0.0

\* Estimates based on equal vulnerability minus estimates derived using the available Alaska scale data.



## Appendix E.9 1990 Sockeye catch by stock.

Fishery	Difference*						Total
	Skeena	Nass	Stikine	US MacD	US Other	Fraser	
Langara	27	-4	0	-22	-1	0	0
1TS	458	-1	0	-455	-2	0	0
3X	15	2	0	-27	11	0	0
3Y+7	7139	-7151	0	-318	330	0	0
3Z-7	0	0	0	0	0	0	0
4W	-108	68	0	0	40	0	0
4X	-37	27	0	0	10	0	0
4Y	0	0	0	0	0	0	0
4Z	0	0	0	0	0	0	0
Area_5	-29	-12	0	0	40	0	0
Noyes	48823	-15752	0	-16839	-16237	0	-4
Dall	46022	-13164	0	-13531	-19329	0	-1
Cordova	4263	211	0	-1679	-2795	0	1
Sumner	306	-9827	11972	-1154	-705	0	593
U_Clar	820	-2771	663	927	1805	0	1443
M_Clar	-499	0	0	443	57	0	0
L_Clar	24272	-11579	0	-4871	-7261	0	561
Revilla	0	0	0	0	0	0	0
Fox	21548	-22067	0	-1244	1899	0	135
Term101	0	0	0	0	0	0	0
Term108	0	0	0	0	0	0	0
Total Catch	153020	-82019	12634	-38772	-42137	0	2728
Escapement	0	0	0	0	0	0	0
Total Run	153020	-82019	12634	-38772	-42137	0	2728
Expl Rate	2.4	-11.2	12.0	-9.3	-4.9	0.0	0.0

\* Estimates based on equal vulnerability minus estimates derived using the available Alaska scale data.

## Appendix E.10 1991 Sockeye catch by stock.

Fishery	Difference*						Total
	Skeena	Nass	Stikine	US MacD	US Other	Fraser	
Langara	-916	35	0	618	263	0	0
1TS	-131	-3	0	123	10	0	0
3X	-2437	-151	0	1843	744	0	0
3Y+7	-11061	-1727	0	4798	7989	0	0
3Z-7	0	0	0	0	0	0	0
4W	-1511	-50	0	0	1561	0	0
4X	-374	-13	0	0	388	0	0
4Y	0	0	0	0	0	0	0
4Z	0	0	0	0	0	0	0
Area_5	-181	-65	0	0	247	0	0
Noyes	9634	5393	0	-7191	-2371	0	5463
Dall	-17250	42338	0	-10477	-13754	0	858
Cordova	1740	560	0	-776	-1517	0	6
Sumner	11338	-9385	5858	-1407	-3560	0	2844
U_Clar	7937	-5470	-2450	696	1108	0	1820
M_Clar	-40	0	0	30	9	0	0
L_Clar	20654	-2983	0	-4476	-12958	0	236
Revilla	0	0	0	0	2	0	2
Fox	-1818	-14094	0	1746	14366	0	200
Term101	0	0	0	0	0	0	0
Term108	0	0	0	0	0	0	0
Total Catch	15584	14387	3408	-14474	-7477	0	11427
Escapement	0	0	0	0	0	0	0
Total Run	15584	14387	3408	-14474	-7476	0	11428
Expl Rate	0.2	0.5	1.5	-2.7	-0.7	0.0	0.1

\* Estimates based on equal vulnerability minus estimates derived using the available Alaska scale data.

## Appendix E.11 1992 Sockeye catch by stock.

Fishery	Difference*						Total
	Skeena	Nass	Stikine	US MacD	US Other	Fraser	
Langara	171	-35	0	-150	15	0	0
1TS	30	0	0	-28	-2	0	0
3X	314	82	0	-195	-200	0	0
3Y+7	9335	-8732	0	-273	-329	0	0
3Z-7	0	0	0	0	0	0	0
4W	258	-30	0	0	-227	0	0
4X	119	-8	0	0	-111	0	0
4Y	0	0	0	0	0	0	0
4Z	0	0	0	0	0	0	0
Area_5	44	13	0	0	-57	0	0
Noyes	-28173	68025	0	-7943	-29538	0	2370
Dall	-52535	103253	0	-16418	-32157	0	2143
Cordova	652	639	0	-994	-296	0	0
Sumner	8104	1133	8128	-199	-13443	0	3724
U_Clar	5262	2607	-4593	603	-1924	0	1956
M_Clar	190	3	0	-45	-90	0	58
L_Clar	13018	6428	0	-6254	-13103	0	89
Revilla	0	0	0	0	-1	0	-1
Fox	50855	-30268	0	-2940	-17391	0	256
Term101	0	0	0	0	0	0	0
Term108	0	0	0	0	0	0	0
Total Catch	7642	143111	3536	-34837	-108857	0	10595
Escapement	0	0	0	0	0	0	0
Total Run	7642	143111	3536	-34837	-108857	0	10595
Expl Rate	0.1	2.5	1.0	-7.2	-7.4	0.0	0.1

\* Estimates based on equal vulnerability minus estimates derived using the available Alaska scale data.

## Appendix E.12 1993 Sockeye catch by stock.

Fishery	Difference*						Total
	Skeena	Nass	Stikine	US MacD	US Other	Fraser	
Langara	-16	-46	0	-5	68	0	0
1TS	0	0	0	0	0	0	0
3X	-202	36	0	98	69	0	0
3Y+7	12101	-13522	0	580	840	0	0
3Z-7	0	0	0	0	0	0	0
4W	-384	206	0	0	178	0	0
4X	-109	92	0	0	18	0	0
4Y	0	0	0	0	0	0	0
4Z	0	0	0	0	0	0	0
Area_5	-3	-35	0	0	39	0	0
Noyes	-35501	62698	0	-2956	-23008	0	1233
Dall	-36232	103759	0	-16140	-51182	0	204
Cordova	886	1938	0	-2476	-345	0	1
Sumner	-11090	3364	-7778	6470	15023	0	5988
U_Clar	-5840	2255	-11637	5344	14176	0	4297
M_Clar	403	797	0	-477	-724	0	0
L_Clar	36510	12242	0	-16373	-32397	0	-18
Revilla	0	0	0	0	0	0	0
Fox	70768	-68875	0	-3990	2298	0	201
Term101	0	0	0	-4	0	0	-4
Term108	0	0	0	0	0	0	0
Total Catch	31287	104908	-19415	-29929	-74947	0	11903
Escapement	0	0	0	0	0	0	0
Total Run	31287	104908	-19415	-29929	-74947	0	11903
Expl Rate	0.3	1.0	-4.3	-2.8	-5.5	0.0	0.1

\* Estimates based on equal vulnerability minus estimates derived using the available Alaska scale data.

## Appendix E.13 1994 Sockeye catch by stock.

Fishery	Difference*						Total
	Skeena	Nass	Stikine	US MacD	US Other	Fraser	
Langara	126	69	0	-196	2	0	0
1TS	0	0	0	0	0	0	0
3X	16	68	0	-71	-13	0	0
3Y+7	1718	-1599	0	-122	3	0	0
3Z-7	0	0	0	0	0	0	0
4W	136	-93	0	0	-44	0	0
4X	21	-8	0	0	-13	0	0
4Y	0	0	0	0	0	0	0
4Z	0	0	0	0	0	0	0
Area_5	-18	-23	0	0	42	0	0
Noyes	-64534	114166	0	-11302	-33090	0	5239
Dall	-867	29985	0	-6000	-23118	0	0
Cordova	395	2476	0	-2224	-606	0	40
Sumner	5386	-534	13956	-2672	-13453	0	2683
U_Clar	2481	2974	-5229	1642	524	0	2392
M_Clar	-2683	538	0	1172	1537	0	565
L_Clar	13131	-2459	0	-839	-8985	0	848
Revilla	0	0	0	0	0	0	0
Fox	21520	-17743	0	-2399	-899	0	480
Term101	0	0	0	0	0	0	0
Term108	0	0	0	0	0	0	0
Total Catch	-23174	127820	8726	-23011	-78113	0	12250
Escapement	0	0	0	0	0	0	0
Total Run	-23174	127820	8726	-23011	-78113	0	12249
Expl Rate	-0.5	5.5	1.5	-5.6	-8.0	0.0	0.1

\* Estimates based on equal vulnerability minus estimates derived using the available Alaska scale data.

## Appendix E.14 1995 Sockeye catch by stock.

Fishery	Difference*						Total
	Skeena	Nass	Stikine	US MacD	US Other	Fraser	
Langara	-123	25	0	1	97	0	0
1TS	0	0	0	0	0	0	0
3X	999	-73	0	-761	-166	0	0
3Y+7	19332	-18331	0	-889	-110	0	1
3Z-7	0	0	0	0	0	0	0
4W	402	-73	0	0	-328	0	0
4X	192	81	0	0	-272	0	0
4Y	0	0	0	0	0	0	0
4Z	0	0	0	0	0	0	0
Area_5	55	30	0	0	-84	0	0
Noyes	21804	10208	0	-9068	-13836	0	9108
Dall	-8055	48449	0	-16513	-15466	0	8416
Cordova	1027	961	0	-1508	-481	0	0
Sumner	-7687	7498	12022	-231	-7450	0	4151
U_Clar	-7418	7622	-951	3980	1476	0	4711
M_Clar	2699	2645	0	-3367	-1966	0	11
L_Clar	11070	23183	0	-9129	-20957	0	4167
Revilla	0	0	0	0	0	0	0
Fox	53375	-45346	0	-2754	-3695	0	1580
Term101	0	0	0	0	0	0	0
Term108	0	0	0	0	0	0	0
Total Catch	87670	36880	11071	-40237	-63239	0	32145
Escapement	0	0	0	0	0	0	0
Total Run	87670	36880	11071	-40237	-63239	0	32145
Expl Rate	0.7	0.8	2.7	-9.6	-10.5	0.0	0.2

\* Estimates based on equal vulnerability minus estimates derived using the available Alaska scale data.

**Appendix F.**  
**Pink Salmon Migration Routing Parameters.**

## Appendix F - Pink Salmon Migration Routing Parameters

F-1

## PINK FISHERIES ORDER

Code	Fishery Label	Order Resid	Code	Simultaneous Label	Resid
30	Term101	2			
31	Term105	2			
32	Term108	2			
4	Masset	2			
27	Revilla	2			
28	Union	2			
12	Area 5	2			
7	3Z-7	2			
11	4Z	2			
10	4Y	1			
9	4X	1			
8	4W	1			
6	3Y+7	1			
5	3X	1			
29	Tree	1			
26	L.Clar	2	25	M.Clar	2
24	U.Clar	2			
23	Sumner	2			
3	1TS	2			
2	1TN	2			
1	Langara	1			
22	Cordova	1			
21	Dall	2			
20	Noyes	2			
13	Refuge	1			

## ROUTING OF STOCKS THROUGH FISHERY

1	Skeena						
4Z	11	10			1.000		
4Y	10	9			1.000		
4X	9	12	8		0.120	0.880	
4W	8	3	5	7	0.520	0.270	0.220
3Z-7	7	6			1.000		
3Y+7	6	5	29		0.750	0.250	
3X	5	3	2		0.200	0.800	
Tree	29	27			1.000		
Revilla	27	26	22		0.300	0.700	
L.Clar	26	22			1.000		
Cordova	22	2			1.000		
1TN	2	21	13		0.400	0.600	
Dall	21	20			1.000		
1TS	3	1			1.000		
2	A4-Is.						
Stock	99	12	9		0.120	0.880	
4X	9	8			1.000		
4W	8	3	5	7	0.520	0.270	0.220
3Z-7	7	6			1.000		
3Y+7	6	5	29		0.750	0.250	
3X	5	3	2		0.200	0.800	
Tree	29	27			1.000		
Revilla	27	26	22		0.300	0.700	
L.Clar	26	22			1.000		
Cordova	22	2			1.000		
1TN	2	21	13		0.400	0.600	
Dall	21	20			1.000		
1TS	3	1			1.000		
3	A3-In						
3Y-7	7	6			1.000		
3y+7	6	8	5	29	0.100	0.600	0.300
4x	9	12			1.000		



## Appendix F - Pink Salmon Migration Routing Parameters

F-2

4W	8	9	3			0.100	0.900		
3X	5	3	29			0.600	0.400		
Tree	29	26	13			0.200	0.800		
L.Clar	26	2				1.000			
1TN	2	21				1.000			
Dall	21	20				1.000			
1TS	3	1	13			0.600	0.400		
4 A3-Out									
3y+7	6	8	5	29		0.100	0.600	0.300	
4x	9	12				1.000			
4W	8	9	3			0.100	0.900		
3X	5	3	29			0.600	0.400		
Tree	29	26	13			0.200	0.800		
L.Clar	26	2				1.000			
1TN	2	21				1.000			
Dall	21	20				1.000			
1TS	3	1	13			0.600	0.400		
5 Area 5									
Area 5	12	9				1.000			
4X	9	8				1.000			
4W	8	5				1.000			
1ST	3	2	1			0.108	0.892		
3X	5	29	3			0.700	0.300		
Tree	29	2				1.000			
6 South									
Stock	99	1	3	12	13	0.190	0.050	0.010	0.750
1ST	3	2	13			0.500	0.500		
Area 5	12	9				1.000			
4X	9	8				1.000			
4W	8	5				1.000			
3X	5	29	13			0.600	0.400		
Tree	29	2				1.000			
1TN	2	21	13			0.200	0.800		
7 Yakoun									
Masset	4	1	3			0.600	0.400		
1ST	3	2	13			0.800	0.200		
1TN	2	21	13			0.500	0.500		
8 US101									
Stock	99	27	29	7	30	0.470	0.360	0.100	0.070
Term101	30	28				1.000			
Revilla	27	26	28	22		0.600	0.200	0.200	
Union	28	24				1.000			
Tree	29	22	6	3		0.450	0.300	0.250	
3Z-7	7	6				1.000			
3Y+7	6	5	8	13		0.300	0.300	0.400	
3X	5	3	22			0.730	0.270		
L.Clar	26	22	25	3		0.500	0.300	0.200	
Cordova	22	2				1.000			
1TN	2	21				1.000			
Dall	21	20	13			0.500	0.500		
4W	8	9	5	13		0.150	0.750	0.100	
4X	9	12				1.000			
1ST	3	1				1.000			
M.Clar	25	24				1.000			
U.Clar	24	23				1.000			
9 US102									
M.Clar	25	24	26			0.180	0.820		
U.Clar	24	23				1.000			
L.Clar	26	22	3	29		0.800	0.100	0.100	
Tree	29	6				1.000			
3y+7	6	5				1.000			
3X	5	22				1.000			

## Appendix F - Pink Salmon Migration Routing Parameters

F-3

---

Cordova	22	2				1.000			
1TN	2	21				1.000			
Dall	21	20				1.000			
1TS	3	1				1.000			
10 US103/4									
Stock	99	20	21	22	26	0.300	0.400	0.200	0.100
Dall	21	20				1.000			
Cordova	22	2	21			0.500	0.500		
1TN	2	3				1.000			
1TS	3	1				1.000			
11 US105/6									
Stock	99	24	28	31		0.550	0.350	0.100	
Term105	31	23				1.000			
Union	28	24				1.000			
U. Clar	24	25	23			0.400	0.600		
M. Clar	25	26	22			0.500	0.500		
L. Clar	26	22				1.000			
Cordova	22	2				1.000			
1TN	2	21				1.000			
Dall	21	20				1.000			
12 US107/8									
Term108	32	24				1.000			
U. Clar	24	25	23			0.500	0.500		
Union	28	24				1.000			
M. Clar	25	26	22			0.500	0.500		
L. Clar	26	22				1.000			
Cordova	22	2				1.000			
1TN	2	21				1.000			
Dall	21	20				1.000			

**Appendix G.**

**Pink Salmon Migration Routing Diagrams.**

### Skeena Pink Salmon Migration Routing

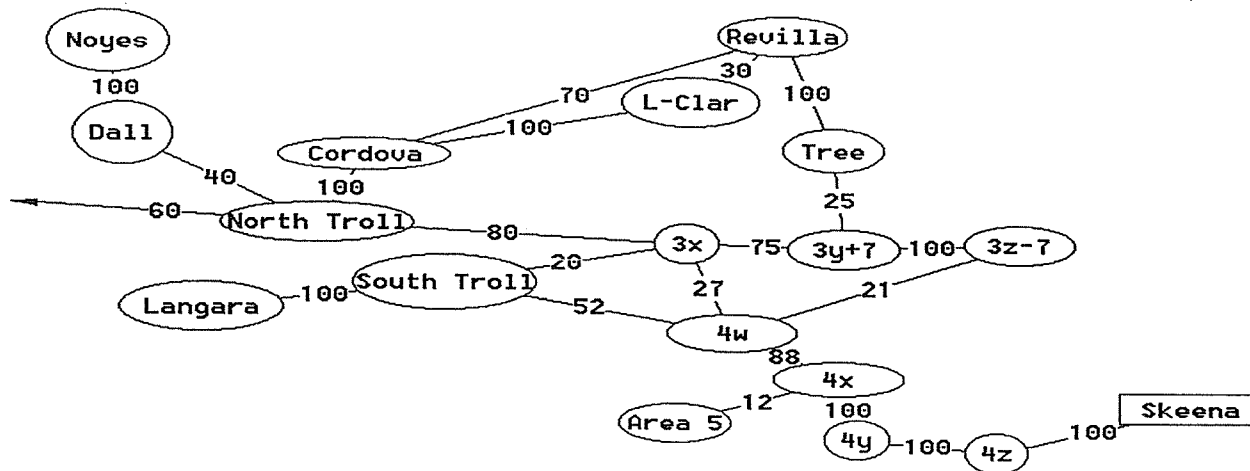

### Area 4 Islands Pink Salmon Migration Routing

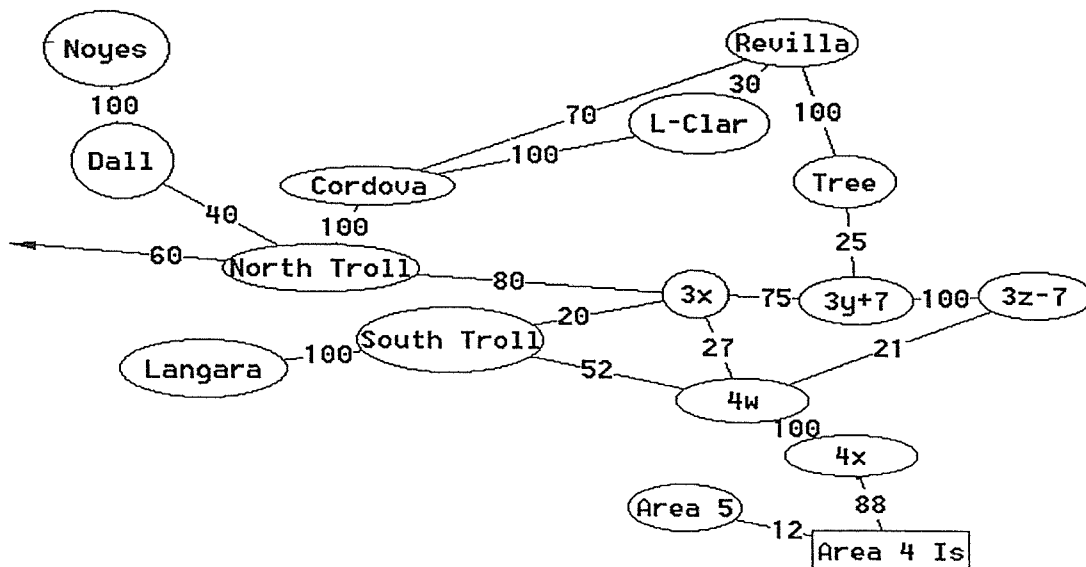

### Area 3 inside Pink Salmon Migration Routing

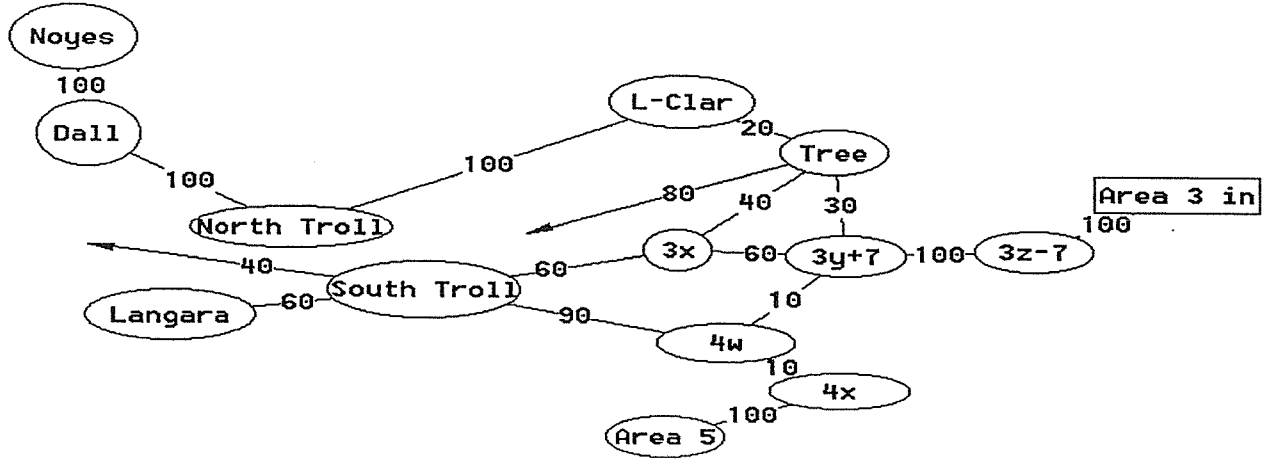

### Area 3 outside Pink Salmon Migration Routing

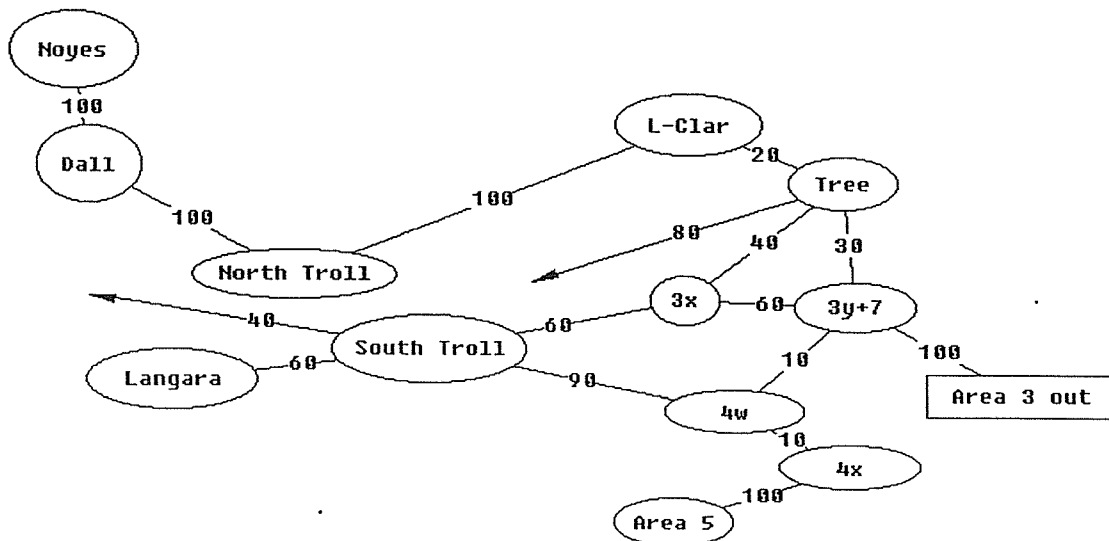

### Area 5 Pink Salmon Migration Routing

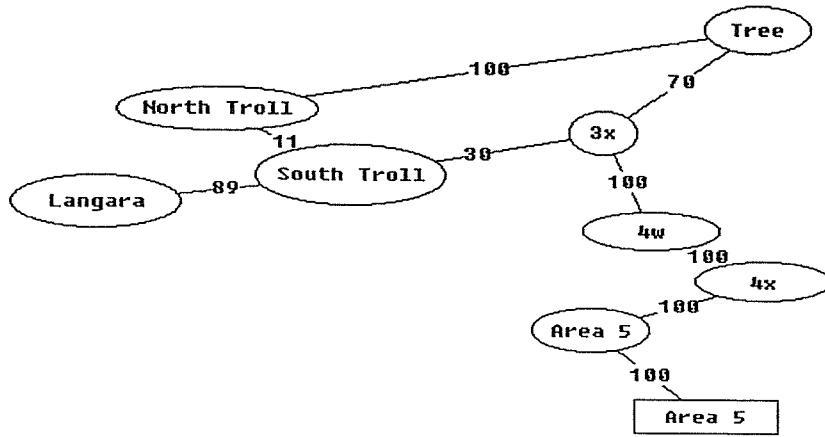

### South Pink Salmon Migration Routing

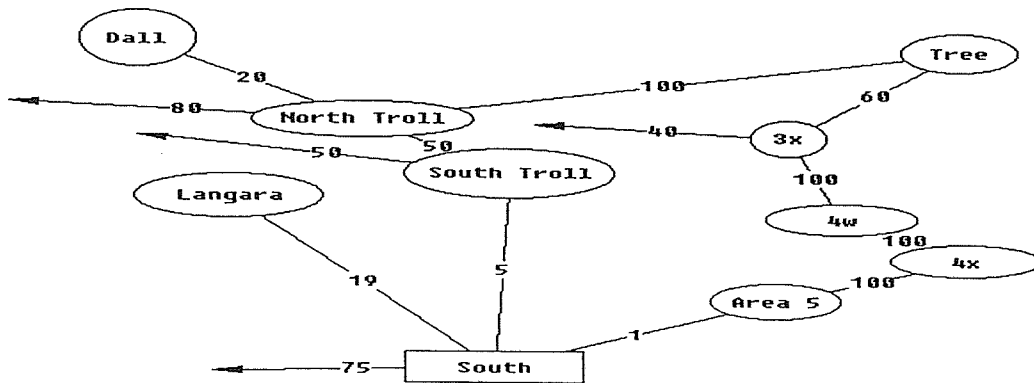

### Yakoun Pink Salmon Migration Routing

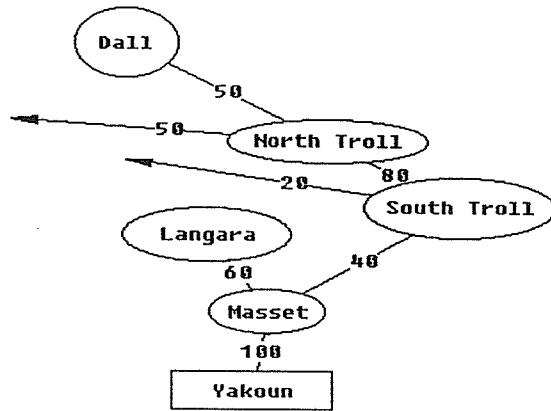

### US 101 Pink Salmon Migration Routing

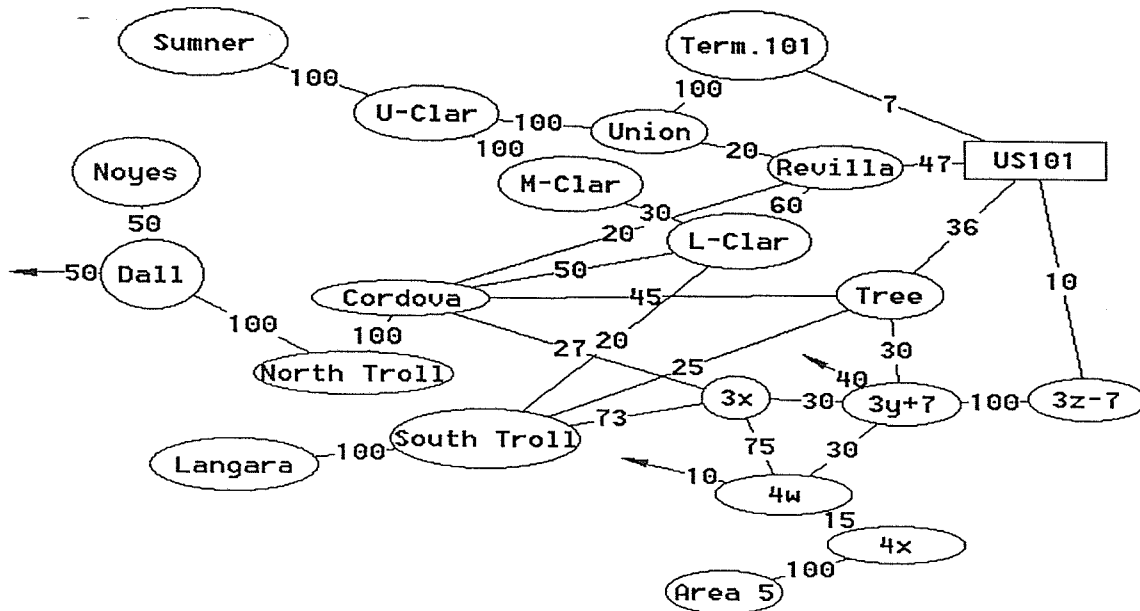

### US 102 Pink Salmon Migration Routing

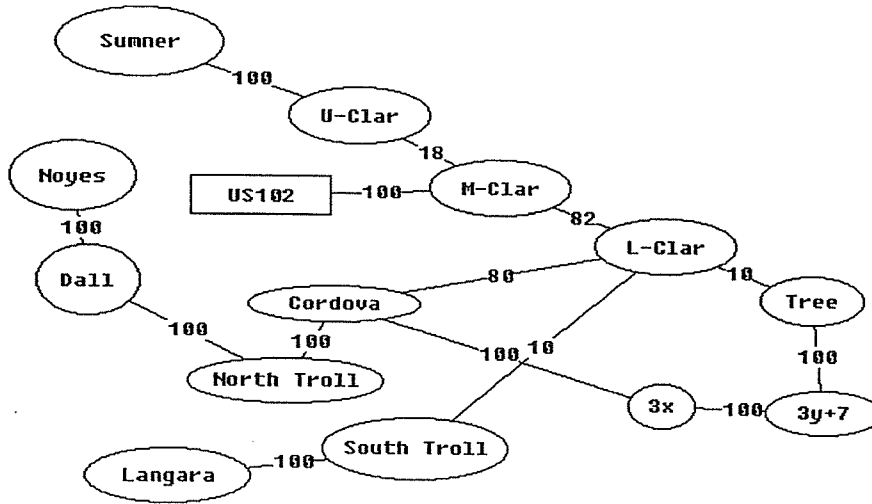

### US 103/4 Pink Salmon Migration Routing

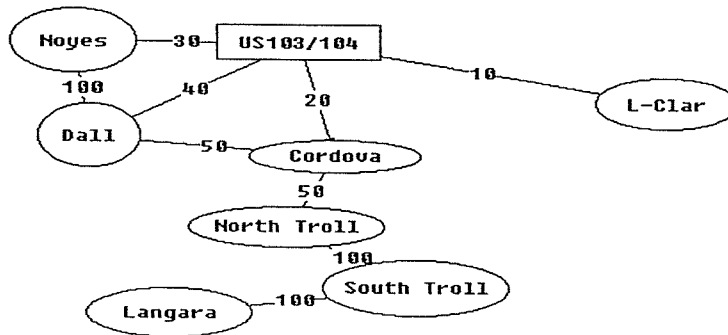



### US 105/6 Pink Salmon Migration Routing

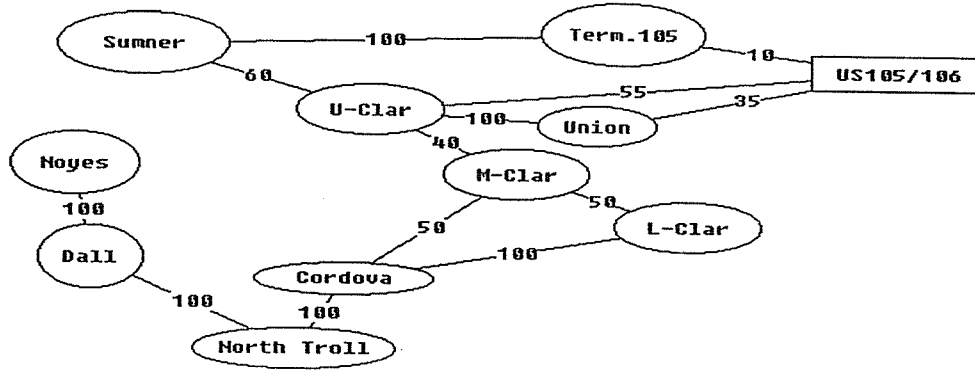

### US 107/8 Pink Salmon Migration Routing

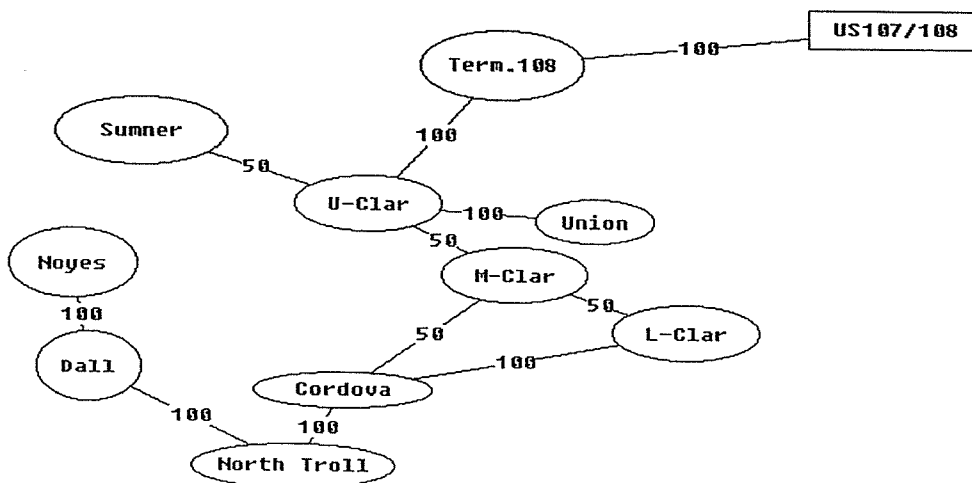

**Appendix H.**

**Pink Salmon Catch by Stock, 1982-95.**

## Appendix H.1 1982 Pink salmon catch by stock.

Fishery	Skeena	A4-Is.	A3-In	A3-Out	Area 5	South	Yakoun	US101	US102	US103/	US105/6	US107/8	Total
Langara	4504	0	1822	0	0	0	0	11506	2	263	0	0	18097
1TN	1632	27	553	11	49	0	79	6905	929	304	362	2312	13162
1TS	5780	260	5693	262	158	0	871	26262	786	2875	0	0	42946
Masset	0	0	0	0	0	0	0	0	0	0	0	0	0
3X	66739	2784	58711	6362	7479	0	0	138909	20760	0	0	0	301743
3Y+7	83009	3088	179987	14255	0	0	0	406539	34816	0	0	0	721693
3Z-7	4733	192	7781	0	0	0	0	9728	0	0	0	0	22435
4W	89203	0	26592	0	0	0	0	82214	0	0	0	0	198009
4X	12884	0	1875	0	0	0	0	9334	0	0	0	0	24094
4Y	0	0	0	0	0	0	0	0	0	0	0	0	0
4Z	26723	0	0	0	0	0	0	0	0	0	0	0	26723
Area_5	20550	246	5525	57	899	0	0	30554	0	0	0	0	57831
Noyes	46124	9909	35391	10725	0	0	0	1227741	847353	1168703	252930	427069	4025944
Dall	18936	1310	13746	2181	0	0	4820	451966	114840	85729	32543	81017	807087
Cordova	1838	1131	0	0	0	0	0	328793	118258	52027	33767	57598	593412
Sumner	0	0	0	0	0	0	0	7621	241	0	690	1619	10170
U_Clar	0	0	0	0	0	0	0	9271	299	0	1067	4386	15022
M_Clar	0	0	0	0	0	0	0	0	0	0	0	0	0
L_Clar	18933	1512	64779	6449	0	0	0	1702573	303535	114173	57176	254941	2524072
Revilla	60037	5621	0	0	0	0	0	2530933	0	0	0	0	2596590
Union	0	0	0	0	0	0	0	103330	0	0	6153	0	109483
Fox	8859	571	45517	6141	7242	0	0	261109	13740	0	0	0	343179
Term101	0	0	0	0	0	0	0	463905	0	0	0	0	463905
Term105	0	0	0	0	0	0	0	0	0	0	99542	0	99542
Term108	0	0	0	0	0	0	0	0	0	0	0	16972	16972
Total Catch	470483	26651	447972	46442	15826	0	5769	7809192	1455559	1424073	484230	845914	13032110
Escapement	655679	83085	347635	79500	70300	0	349999	5537763	1450005	5260798	1486958	1327110	16648830
Total Run	1126162	109736	795607	125942	86126	0	355768	13346950	2905564	6684870	1971187	2173024	29680940
Expl Rate	41.8	24.3	56.3	36.9	18.4	0.0	1.6	58.5	50.1	21.3	24.6	38.9	43.9

## Appendix H.2 1983 Pink salmon catch by stock.

Fishery	Skeena	A4-Is.	A3-In	A3-Out	Area 5	South	Yakoun	US101	US102	US103/	US105/6	US107/8	Total
Langara	33554	184	4606	30	156	43413	0	42292	3970	5779	0	0	133985
1TN	10858	95	1171	6	213	1697	0	14420	8340	2839	3119	2711	45468
1TS	36719	1009	14162	144	636	14265	0	55449	5927	20030	0	0	148341
Masset	0	0	0	0	0	0	0	0	0	0	0	0	0
3X	379928	896	188286	310	1096	29211	0	260369	73964	0	0	0	934059
3Y+7	1964866	2054	1468531	1809	0	0	0	2520087	270090	0	0	0	6227436
3Z-7	89305	172	72863	0	0	0	0	62448	0	0	0	0	224788
4W	138231	763	11644	28	593	10353	0	71026	0	0	0	0	232638
4X	94348	303	622	1	335	6146	0	5370	0	0	0	0	107127
4Y	0	0	0	0	0	0	0	0	0	0	0	0	0
4Z	298830	0	0	0	0	0	0	0	0	0	0	0	298830
Area_5	73028	715	2039	28	3838	31547	0	19755	0	0	0	0	130949
Noyes	1144976	8921	358197	2233	0	0	0	3270162	4594421	2011322	953961	874947	13219140
Dall	605190	1836	228601	678	0	60984	0	2371438	1656943	180735	194385	418312	5719103
Cordova	3677	219	0	0	0	0	0	188897	181859	41510	40235	9012	465409
Sumner	0	0	0	0	0	0	0	50690	7018	0	8843	7592	74143
U_Clar	0	0	0	0	0	0	0	682973	113887	0	105044	100599	1002504
M_Clar	0	0	0	0	0	0	0	249844	749812	0	155259	30669	1185585
L_Clar	70068	469	109207	604	0	0	0	1125632	721299	183235	104298	137787	2452601
Revilla	866490	1471	0	0	0	0	0	2493174	0	0	0	0	3361135
Union	0	0	0	0	0	0	0	604000	0	0	81065	0	685065
Fox	81942	182	121954	347	2509	35905	0	486974	43021	0	0	0	772833
Term101	0	0	0	0	0	0	0	0	0	0	0	0	0
Term105	0	0	0	0	0	0	0	0	0	0	235554	0	235554
Term108	0	0	0	0	0	0	0	0	0	0	0	4159	4159
Total Catch	5892009	19289	2581884	6216	9377	233522	0	14575000	8430552	2445450	1881765	1585789	37660850
Escapement	2580557	72954	724985	13220	81025	15170000	0	7002473	2495523	8077965	1989618	1001343	39209660
Total Run	8472566	92243	3306869	19436	90402	15403520	0	21577470	10926070	10523420	3871382	2587132	76870510
Expl Rate	69.5	20.9	78.1	32.0	10.4	1.5	0.0	67.6	77.2	23.2	48.6	61.3	49.0

## Appendix H.3 1984 Pink salmon catch by stock.

Fishery	Skeena	A4-Is.	A3-In	A3-Out	Area 5	South	Yakoun	US101	US102	US103/	US105/6	US107/8	Total
Langara	11326	92	2875	68	642	0	1837	39782	2746	4172	0	0	63540
ITN	79546	954	11362	302	7396	0	29842	344756	125947	33766	23869	48544	706286
ITS	64814	1853	34605	1191	4336	0	39672	254051	17146	53266	0	0	470934
Masset	0	0	0	0	0	0	617453	0	0	0	0	0	617453
3X	175555	1599	102144	2670	13289	0	0	250381	52746	0	0	0	598382
3Y+7	265810	611	428434	1790	0	0	0	843817	54369	0	0	0	1594831
3Z-7	41597	145	47511	0	0	0	0	66658	0	0	0	0	155911
4W	226328	340	20668	83	1266	0	0	174425	0	0	0	0	423111
4X	85921	86	1896	3	825	0	0	25154	0	0	0	0	113885
4Y	125131	0	0	0	0	0	0	0	0	0	0	0	125131
4Z	215495	0	0	0	0	0	0	0	0	0	0	0	215495
Area_5	321487	4116	10776	564	52807	0	0	187218	0	0	0	0	576969
Noyes	82371	3080	40047	3279	0	0	0	1127234	1109704	1343640	163130	378280	4250766
Dall	108308	1178	45166	1744	0	0	71489	1694948	642049	276914	72170	240956	3154923
Cordova	1769	379	0	0	0	0	0	406143	239984	110946	35150	80409	874780
Sumner	0	0	0	0	0	0	0	79289	4052	0	7586	8881	99807
U_Clar	0	0	0	0	0	0	0	240473	15788	0	19879	73472	349613
M_Clar	0	0	0	0	0	0	0	55153	109234	0	12554	34640	211581
L_Clar	103404	606	109474	2893	0	0	0	2252520	980300	294689	73597	272557	4090041
Revilla	589219	521	0	0	0	0	0	2756393	0	0	0	0	3346133
Union	0	0	0	0	0	0	0	147977	0	0	8932	0	156909
Fox	55060	157	104064	1201	10817	0	0	527460	17404	0	0	0	716163
Term101	0	0	0	0	0	0	0	410126	0	0	0	0	410126
Term105	0	0	0	0	0	0	0	0	0	0	149866	0	149866
Term108	0	0	0	0	0	0	0	0	0	0	0	4960	4960
Total Catch	2553142	15719	959024	15787	91378	0	760294	11883960	3371469	2117393	566734	1142699	23477590
Escapement	978353	58845	494225	36810	162450	0	1106233	9201470	2390603	8361803	1401515	1118495	25310800
Total Run	3531495	74564	1453249	52597	253828	0	1866527	21085430	5762072	10479200	1968249	2261194	48788400
Expl Rate	72.3	21.1	66.0	30.0	36.0	0.0	40.7	56.4	58.5	20.2	28.8	50.5	48.1

## Appendix H.4 1985 Pink salmon catch by stock

Fishery	Skeena	A4-Is.	A3-In	A3-Out	Area 5	South	Yakoun	US101	US102	US103/	US105/6	US107/8	Total
Langara	54297	223	4020	42	110	95909	0	61083	2038	7209	0	0	224932
1TN	91335	0	5953	0	0	21397	0	15040	40	0	49	19816	153630
1TS	129585	3230	24633	668	2408	71256	0	218716	15511	67433	0	0	533439
Masset	0	0	0	0	0	0	0	0	0	0	0	0	0
3X	165993	460	35410	24	228	28268	0	83694	9778	0	0	0	323855
3Y+7	683296	2756	395117	1599	0	0	0	925565	63510	0	0	0	2071844
3Z-7	114760	409	54280	0	0	0	0	66153	0	0	0	0	235601
4W	468981	2908	22949	203	2676	85446	0	169667	0	0	0	0	752829
4X	236472	699	1846	5	690	52796	0	21666	0	0	0	0	314174
4Y	119273	0	0	0	0	0	0	0	0	0	0	0	119273
4Z	509860	0	0	0	0	0	0	0	0	0	0	0	509860
Area_5	153974	434	3661	73	0	85047	0	52779	0	0	0	0	295969
Noyes	367118	10375	67938	3508	0	22665	0	1082166	308109	251442	122587	267966	2238061
Dall	141812	1619	38805	890	0	0	0	1202690	446890	232549	150136	304051	2351159
Cordova	13505	1339	0	0	0	0	0	255883	3509	0	24790	35114	319296
Sumner	0	0	0	0	0	0	0	222758	18513	0	65579	140807	447656
U_Clar	0	0	0	0	0	0	0	33730	97695	0	33635	41178	206238
M_Clar	0	0	0	0	0	0	0	2264020	856773	418722	218530	421357	4334983
L_Clar	81040	1371	70996	2172	0	0	0	2612736	0	0	0	0	3175929
Revilla	560590	2603	0	0	0	0	0	610	0	0	210	0	820
Union	0	0	0	0	0	0	0	427762	16154	0	0	0	690707
Fox	78265	352	84314	820	3339	79701	0	1816692	0	0	0	0	1816692
Term101	0	0	0	0	0	0	0	0	0	0	0	0	0
Term105	0	0	0	0	0	0	0	0	0	0	1336581	0	1336581
Term108	0	0	0	0	0	0	0	0	0	0	0	2506	2506
Total Catch	3970156	28780	809922	10004	9450	542485	0	14532420	4229181	4298833	2851833	2772533	34055600
Escapement	2057203	130130	479061	29794	176075	18863000	0	9635918	2917718	11949990	3909188	2562958	52711030
Total Run	6027360	158910	1288983	39798	185525	19405480	0	24168340	7146899	16248820	6761020	5335491	86766630
Expl Rate	65.9	18.1	62.8	25.1	5.1	2.8	0.0	60.1	59.2	26.5	42.2	52.0	39.3

## Appendix H.5 1986 Pink salmon catch by stock.

Fishery	Skeena	A4-Is.	A3-In	A3-Out	Area 5	South	Yakoun	US101	US102	US103/	US105/6	US107/8	Total
Langara	64260	24950	7061	5464	46820	0	83185	229537	80375	298871	0	0	840523
1TN	5266	0	327	0	0	0	0	21806	20	1	0	7336	34756
1TS	55586	2719	11866	1387	7473	0	4424	226116	14617	55672	0	0	379860
Masset	0	0	0	0	0	0	0	0	0	0	0	0	0
3X	118821	186	24186	0	0	0	0	158731	11010	0	0	0	312934
3Y+7	527104	9378	194783	19289	0	0	0	1560860	184713	0	0	0	2496127
3Z-7	158738	1704	68846	0	0	0	0	311951	0	0	0	0	541239
4W	197805	7129	6238	672	17678	0	0	147245	0	0	0	0	376766
4X	149567	3131	427	45	15716	0	0	16587	0	0	0	0	185473
4Y	149454	0	0	0	0	0	0	0	0	0	0	0	149454
4Z	676504	0	0	0	0	0	0	0	0	0	0	0	676504
Area_5	708798	38889	7878	3017	430340	0	0	302226	0	0	0	0	1491149
Noyes	511698	16224	46815	8786	0	0	0	2654038	2873157	3254570	802402	665235	10832930
Dall	605740	11205	85114	11958	0	0	7321	5734914	2030561	1278998	626041	672857	11064710
Cordova	20823	5753	0	0	0	0	0	1194303	1209132	654953	300517	157833	3543314
Sumner	0	0	0	0	0	0	0	69049	7013	0	21723	7488	105273
U_Clar	0	0	0	0	0	0	0	261536	23704	0	73632	56021	414892
M_Clar	0	0	0	0	0	0	0	292594	304507	0	84036	70451	751589
L_Clar	105545	3269	43248	7858	0	0	0	3399075	1472790	636601	261622	262131	6192139
Revilla	572968	10191	0	0	0	0	0	5604284	0	0	0	0	6187443
Union	0	0	0	0	0	0	0	127768	0	0	19144	0	146912
Fox	27732	1186	28924	6611	75638	0	0	700179	57470	0	0	0	897739
Term101	0	0	0	0	0	0	0	479081	0	0	0	0	479081
Term105	0	0	0	0	0	0	0	0	0	0	407439	0	407439
Term108	0	0	0	0	0	0	0	0	0	0	0	4899	4899
Total Catch	4656408	135913	525712	65087	593664	0	94931	23491880	8269069	6179667	2596557	1904252	48513140
Escapement	2088574	233563	273325	101920	313900	0	439507	11320860	4403700	14902770	3742505	1598503	39419120
Total Run	6744982	369476	799037	167007	907564	0	534438	34812740	12672770	21082430	6339062	3502755	87932260
Expl Rate	69.0	36.8	65.8	39.0	65.4	0.0	17.8	67.5	65.3	29.3	41.0	54.4	55.2

## Appendix H.6 1987 Pink salmon catch by stock.

Fishery	Skeena	A4-Is.	A3-In	A3-Out	Area 5	South	Yakoun	US101	US102	US103/	US105/6	US107/8	Total
Langara	53878	434	2354	82	315	24766	0	33556	1710	17358	0	0	134454
1TN	248256	0	4584	0	0	9072	0	40250	2766	54	3306	11707	319997
1TS	621987	17006	63900	2303	10754	62836	0	333448	19074	57637	0	0	1188945
Masset	0	0	0	0	0	0	0	0	0	0	0	0	0
3X	114155	494	16036	107	543	5499	0	37176	4864	0	0	0	178874
3Y+7	1252308	2253	305239	1267	0	0	0	805784	51106	0	0	0	2417957
3Z-7	691391	932	155259	0	0	0	0	234625	0	0	0	0	1082207
4W	291069	2147	5981	55	1221	12430	0	62091	0	0	0	0	374994
4X	259865	2126	485	12	2180	10826	0	8734	0	0	0	0	284228
4Y	194019	0	0	0	0	0	0	0	0	0	0	0	194019
4Z	928127	0	0	0	0	0	0	0	0	0	0	0	928127
Area_5	258520	2811	3874	133	4620	63083	0	58495	0	0	0	0	391536
Noyes	134370	1063	15106	60	0	0	0	200739	106873	161608	28392	68910	717122
Dall	161515	882	15012	87	0	12436	0	421941	95753	133896	31974	83319	956814
Cordova	1435	349	0	0	0	0	0	84183	40131	71201	15887	9590	222777
Summer	0	0	0	0	0	0	0	91911	2383	0	7405	14821	116519
U_Clar	0	0	0	0	0	0	0	76573	2994	0	12444	34347	126358
M_Clar	0	0	0	0	0	0	0	0	0	0	0	0	0
L_Clar	15428	214	11117	159	0	0	0	191174	99583	33654	16486	35136	402952
Revilla	363475	623	0	0	0	0	0	505179	0	0	0	0	869277
Union	0	0	0	0	0	0	0	0	0	0	0	0	0
Fox	155065	334	52612	436	3759	22802	0	334801	10376	0	0	0	580185
Term101	0	0	0	0	0	0	0	0	0	0	0	0	0
Term105	0	0	0	0	0	0	0	0	0	0	51	0	51
Term108	0	0	0	0	0	0	0	0	0	0	0	3243	3243
Total Catch	5744864	31669	651560	4701	23392	223751	0	3520660	437612	475408	115944	261074	11490640
Escapement	3199881	142143	348616	23750	127950	7136000	0	5624618	1295400	5042735	976645	1094838	25012570
Total Run	8944744	173812	1000176	28451	151342	7359751	0	9145277	1733012	5518143	1092589	1355911	36503210
Expl Rate	64.2	18.2	65.1	16.5	15.5	3.0	0.0	38.5	25.3	8.6	10.6	19.3	31.5



## Appendix H.7 1988 Pink salmon catch by stock.

Fishery	Skeena	A4-Is.	A3-In	A3-Out	Area 5	South	Yakoun	US101	US102	US103/	US105/6	US107/8	Total
Langara	32111	444	2572	160	1467	0	3070	58514	2517	2977	0	0	103831
1TN	8627	0	483	0	0	0	0	11631	136	0	0	2123	23000
1TS	612566	9864	118750	6519	15778	0	81606	1052220	33131	92378	0	0	2022812
Masset	0	0	0	0	0	0	81504	0	0	0	0	0	81504
3X	51989	320	17351	258	258	0	0	59348	2702	0	0	0	132226
3Y+7	87566	602	57577	1631	0	0	0	206446	10793	0	0	0	364615
3Z-7	30785	39	15360	0	0	0	0	19338	0	0	0	0	65522
4W	104338	325	10889	45	298	0	0	46849	0	0	0	0	162743
4X	119464	432	767	5	611	0	0	8381	0	0	0	0	129660
4Y	89099	0	0	0	0	0	0	0	0	0	0	0	89099
4Z	206352	0	0	0	0	0	0	0	0	0	0	0	206352
Area_5	221035	4499	5260	316	24986	0	0	81052	0	0	0	0	337148
Noyes	64716	5248	9789	2884	0	0	0	504974	486438	726837	168091	230184	2199161
Dall	56738	2722	7803	1768	0	0	34607	701729	310893	196605	101848	153891	1568605
Cordova	1115	1205	0	0	0	0	0	317848	258367	140190	83530	89574	891828
Sumner	0	0	0	0	0	0	0	8664	313	0	344	1568	10888
U_Clar	0	0	0	0	0	0	0	34879	2574	0	4483	16643	58579
M_Clar	0	0	0	0	0	0	0	0	0	0	0	0	0
L_Clar	12778	780	11735	2394	0	0	0	709541	362580	132487	64174	109646	1406115
Revilla	268039	818	0	0	0	0	0	1115593	0	0	0	0	1384451
Union	0	0	0	0	0	0	0	0	0	0	0	0	0
Fox	16377	148	23380	537	4784	0	0	172698	3180	0	0	0	221104
Term101	0	0	0	0	0	0	0	0	0	0	0	0	0
Term105	0	0	0	0	0	0	0	0	0	0	18334	0	18334
Term108	0	0	0	0	0	0	0	0	0	0	0	136	136
Total Catch	1983696	27447	281717	16516	48183	0	200787	5109703	1473624	1291473	440805	603766	11477710
Escapement	720500	106325	140950	44165	162000	0	447117	3897128	1432878	3767233	1053748	925985	12698030
Total Run	2704196	133772	422667	60681	210183	0	647904	9006830	2906501	5058706	1494552	1529751	24175740
Expl Rate	73.4	20.5	66.7	27.2	22.9	0.0	31.0	56.7	50.7	25.5	29.5	39.5	47.5

## Appendix H.8 1989 Pink salmon catch by stock.

Fishery	Skeena	A4-Is.	A3-In	A3-Out	Area 5	South	Yakoun	US101	US102	US103/	US105/6	US107/8	Total
Langara	58521	647	3203	70	108	34094	0	44812	3130	5893	0	0	150478
1TN	65491	0	2490	0	0	6563	0	28595	6152	451	1241	21018	132001
ITS	476794	33404	65036	3267	9880	122458	0	418697	31209	84585	0	0	1245329
Masset	0	0	0	0	0	0	0	0	0	0	0	0	0
3X	161931	3373	39881	400	1493	19940	0	81117	48718	0	0	0	356852
3Y+7	969139	14866	407843	4315	0	0	0	1025623	258805	0	0	0	2680591
3Z-7	475528	3732	177389	0	0	0	0	232107	0	0	0	0	888756
4W	87345	738	3558	5	40	9182	0	20937	0	0	0	0	121805
4X	271814	4768	616	8	598	14772	0	8107	0	0	0	0	300683
4Y	203200	0	0	0	0	0	0	0	0	0	0	0	203200
4Z	349537	0	0	0	0	0	0	0	0	0	0	0	349537
Area_5	190776	5202	3906	93	9786	60401	0	49477	0	0	0	0	319641
Noyes	484308	26192	101056	3907	0	0	0	1653865	1428744	1630923	521639	795572	6646206
Dall	397139	20611	75050	2220	0	27769	0	2967616	1217052	855304	414471	740764	6717995
Cordova	88352	5423	0	0	0	0	0	647445	308386	105131	99110	168976	1422822
Sumner	0	0	0	0	0	0	0	322798	10520	0	20002	64726	418046
U_Clar	0	0	0	0	0	0	0	758041	37592	0	86747	268752	1151132
M_Clar	0	0	0	0	0	0	0	218412	401880	0	123422	191398	935111
L_Clar	577371	15919	211926	3675	0	0	0	6287632	2140137	687276	361216	914631	11199780
Revilla	1559228	37976	0	0	0	0	0	7810255	0	0	0	0	9407460
Union	0	0	0	0	0	0	0	729178	0	0	146297	0	875475
Fox	233101	3366	165165	3435	17379	77858	0	791285	56259	0	0	0	1347848
Term101	0	0	0	0	0	0	0	52722	0	0	0	0	52722
Term105	0	0	0	0	0	0	0	0	0	0	0	0	0
Term108	0	0	0	0	0	0	0	0	0	0	0	315331	315331
Total Catch	6649575	176218	1257118	21395	39283	373037	0	24148720	5948584	3369563	1774147	3481166	47238800
Escapement	4204926	468700	598610	42500	178575	16666000	0	7127338	2337113	7310478	2453865	2531498	43919600
Total Run	10854500	644918	1855728	63895	217858	17039040	0	31276060	8285696	10680040	4228012	6012664	91158410
Expl Rate	61.3	27.3	67.7	33.5	18.0	2.2	0.0	77.2	71.8	31.6	42.0	57.9	51.8

Appendix H.9 1990 Pink salmon catch by stock.

Fishery	Skeena	A4-Is.	A3-In	A3-Out	Area 5	South	Yakoun	US101	US102	US103/	US105/6	US107/8	Total
Langara	133636	64	1473	20	46	0	1858	89611	1133	3589	0	0	231430
1TN	8177	0	163	0	0	0	0	12346	66	0	34	4841	25627
1TS	541021	4798	19162	1032	4829	0	37270	463436	24553	43160	0	0	1139260
Masset	0	0	0	0	0	0	1128722	0	0	0	0	0	1128722
3X	110621	657	7447	467	1101	0	0	62499	13511	0	0	0	196303
3Y+7	317468	2016	43147	2755	0	0	0	419440	46447	0	0	0	831274
3Z-7	29867	272	4736	0	0	0	0	19948	0	0	0	0	54824
4W	96760	335	902	29	478	0	0	25201	0	0	0	0	123706
4X	115177	1541	88	7	3463	0	0	4014	0	0	0	0	124290
4Y	174880	0	0	0	0	0	0	0	0	0	0	0	174880
4Z	579797	0	0	0	0	0	0	0	0	0	0	0	579797
Area_5	628286	2194	2344	183	5195	0	0	108511	0	0	0	0	746713
Noyes	485454	13632	21234	5854	0	0	0	1804303	2402657	1481059	1475549	839336	8529077
Dall	410070	7249	18846	4005	0	0	140070	2864744	1562647	462721	942618	731918	7144887
Cordova	71949	2291	0	0	0	0	0	794570	459930	99572	279869	178752	1886933
Sumner	0	0	0	0	0	0	0	46583	4809	0	20611	12057	84061
U_Clar	0	0	0	0	0	0	0	161973	27844	0	173879	102220	465916
M_Clar	0	0	0	0	0	0	0	97158	268662	0	174659	72665	613143
L_Clar	62903	1376	12387	2750	0	0	0	1341533	790618	144189	274329	236744	2866830
Revilla	265606	3564	0	0	0	0	0	1984516	0	0	0	0	2253686
Union	0	0	0	0	0	0	0	65240	0	0	58242	0	123482
Fox	36040	1069	14279	3961	25725	0	0	452256	40580	0	0	0	573911
Term101	0	0	0	0	0	0	0	0	0	0	0	0	0
Term105	0	0	0	0	0	0	0	0	0	0	121925	0	121925
Term108	0	0	0	0	0	0	0	0	0	0	0	13821	13821
Total Catch	4067713	41060	146210	21063	40837	0	1307919	10817880	5643456	2234290	3521716	2192354	30034500
Escapement	2514882	141100	117518	37300	212120	0	1030357	5429153	2768905	5849700	2291825	1377073	21769930
Total Run	6582595	182160	263728	58363	252957	0	2338276	16247030	8412361	8083990	5813541	3569426	51804430
Expl Rate	61.8	22.5	55.4	36.1	16.1	0.0	55.9	66.6	67.1	27.6	60.6	61.4	58.0

## Appendix H.10 1991 Pink salmon catch by stock.

Fishery	Skeena	A4-Is.	A3-In	A3-Out	Area 5	South	Yakoun	US101	US102	US103/	US105/6	US107/8	Total
Langara	107173	244	4143	0	0	82571	0	40810	3286	1694	0	0	239921
1TN	56033	0	1583	0	0	3524	0	3602	4	1	81	6791	71620
1TS	794279	15420	117257	2581	2505	194272	0	371594	20628	57008	0	0	1575545
Masset	0	0	0	0	0	0	0	0	0	0	0	0	0
3X	1389506	2579	133091	192	92	116334	0	334289	77409	0	0	0	2033493
3Y+7	4286133	13279	712575	6673	0	0	0	1574694	182896	0	0	0	6776251
3Z-7	1747560	2998	393508	0	0	0	0	442640	0	0	0	0	2586706
4W	135563	1134	4121	78	227	12053	0	33015	0	0	0	0	186191
4X	218088	1463	997	11	357	18636	0	6478	0	0	0	0	246030
4Y	769162	0	0	0	0	0	0	0	0	0	0	0	769162
4Z	600896	0	0	0	0	0	0	0	0	0	0	0	600896
Area_5	322399	3195	4141	152	3248	118619	0	43152	0	0	0	0	494906
Noyes	2743744	85817	191077	21173	0	0	0	4070670	3046615	4188675	1900205	2299467	18547440
Dall	2618545	33735	270933	8554	0	164165	0	4947121	2219051	808907	900608	1251101	13222720
Cordova	129644	3964	0	0	0	0	0	558176	183849	88174	120685	144215	1228707
Sumner	0	0	0	0	0	0	0	27128	1498	0	11539	20489	60655
U_Clar	0	0	0	0	0	0	0	78960	6156	0	62298	77076	224490
M_Clar	0	0	0	0	0	0	0	7070	11077	0	6012	9820	33980
L_Clar	824776	2774	155614	2745	0	0	0	1355012	538595	111724	177086	308691	3477018
Revilla	1961737	8060	0	0	0	0	0	1661304	0	0	0	0	3631101
Union	0	0	0	0	0	0	0	51296	0	0	36739	0	88035
Fox	165224	786	59970	2207	2755	76113	0	277962	15337	0	0	0	600354
Term101	0	0	0	0	0	0	0	7445	0	0	0	0	7445
Term105	0	0	0	0	0	0	0	0	0	0	711107	0	711107
Term108	0	0	0	0	0	0	0	0	0	0	0	480206	480206
Total Catch	18870460	175447	2049010	44366	9186	786288	0	15892420	6306401	5256182	3926360	4597857	57913980
Escapement	4728459	308956	309600	65950	79610	22330000	0	5099088	1515150	6238848	2692125	1904050	45271840
Total Run	23598920	484403	2358610	110316	88796	23116290	0	20991510	7821551	11495030	6618485	6501907	1.03E+08
Expl Rate	80.0	36.2	86.9	40.2	10.3	3.4	0.0	75.7	80.6	45.7	59.3	70.7	56.1

## Appendix H.11 1992 Pink salmon catch by stock.

Fishery	Skeena	A4-Is.	A3-In	A3-Out	Area 5	South	Yakoun	US101	US102	US103/	US105/6	US107/8	Total
Langara	80175	67	2486	36	30	0	1010	114876	4215	5808	0	0	208703
1TN	17535	0	364	0	0	0	0	41340	1301	1	498	9962	70999
1TS	150310	2272	16549	1466	1657	0	57585	369179	30595	65697	0	0	695310
Masset	0	0	0	0	0	0	236496	0	0	0	0	0	236496
3X	162878	77	13515	112	110	0	0	145241	9805	0	0	0	331738
3Y+7	277172	736	87745	2047	0	0	0	776756	86362	0	0	0	1230818
3Z-7	67324	217	20839	0	0	0	0	98676	0	0	0	0	187056
4W	408014	569	6672	51	314	0	0	199442	0	0	0	0	615062
4X	311882	831	726	14	675	0	0	32913	0	0	0	0	347040
4Y	195592	0	0	0	0	0	0	0	0	0	0	0	195592
4Z	582989	0	0	0	0	0	0	0	0	0	0	0	582989
Area_5	129392	364	1843	59	1324	0	0	81819	0	0	0	0	214801
Noyes	253813	1865	21219	1341	0	0	0	1408619	1057129	580935	245861	556539	4127322
Dall	162765	1575	24111	2543	0	0	86598	2278116	1176761	504875	239502	434707	4911552
Cordova	1288	243	0	0	0	0	0	244911	173396	72122	38207	40420	570588
Sumner	0	0	0	0	0	0	0	26775	2195	0	3702	5791	38463
U_Clar	0	0	0	0	0	0	0	31639	3029	0	6876	14199	55744
M_Clar	0	0	0	0	0	0	0	123078	200050	0	44721	64414	432262
L_Clar	36090	372	15209	1756	0	0	0	1211730	831561	219311	114110	204450	2634590
Revilla	350210	1453	0	0	0	0	0	3658600	0	0	0	0	4010263
Union	0	0	0	0	0	0	0	241930	0	0	47443	0	289373
Fox	21979	192	17026	1581	2700	0	0	505553	32174	0	0	0	581203
Term101	0	0	0	0	0	0	0	89009	0	0	0	0	89009
Term105	0	0	0	0	0	0	0	0	0	0	9740	0	9740
Term108	0	0	0	0	0	0	0	0	0	0	0	180064	180064
Total Catch	3209406	10833	228303	11006	6810	0	381689	11680200	3608573	1448750	750661	1510545	22846780
Escapement	902312	38063	171985	23513	43417	0	680642	7771743	2377980	5026345	1009143	1557233	19602370
Total Run	4111718	48896	400288	34519	50227	0	1062332	19451950	5986554	6475095	1759803	3067778	42449150
Expl Rate	78.1	22.2	57.0	31.9	13.6	0.0	35.9	60.1	60.3	22.4	42.7	49.2	53.8

## Appendix H.12 1993 Pink salmon catch by stock.

Fishery	Skeena	A4-Is.	A3-In	A3-Out	Area 5	South	Yakoun	US101	US102	US103/	US105/6	US107/8	Total
Langara	11334	61	3824	11	6	57101	0	35803	3584	3717	0	0	115442
1TN	151657	91	18592	8	52	101220	0	202409	66365	6609	35796	226295	809094
1TS	13726	756	5510	285	236	16113	0	32122	3992	12881	0	0	85621
Masset	0	0	0	0	0	0	0	0	0	0	0	0	0
3X	77217	86	26503	11	6	32627	0	65629	19589	0	0	0	221668
3Y+7	196583	1188	177677	1398	0	0	0	464164	89232	0	0	0	930242
3Z-7	261171	5343	302879	0	0	0	0	494011	0	0	0	0	1063404
4W	105152	213	5084	19	50	44262	0	51100	0	0	0	0	205881
4X	73635	174	660	1	37	26075	0	9408	0	0	0	0	109991
4Y	58763	0	0	0	0	0	0	0	0	0	0	0	58763
4Z	182460	0	0	0	0	0	0	0	0	0	0	0	182460
Area_5	8039	8	798	0	0	12889	0	7884	0	0	0	0	29619
Noyes	140491	13552	74250	6099	0	0	0	1462762	2476827	5076152	1527032	504202	11281370
Dall	214481	5318	111264	3612	0	74878	0	1865680	1369690	997689	853335	586943	6082891
Cordova	2533	1578	0	0	0	0	0	324376	270128	184658	180015	27625	990913
Sumner	0	0	0	0	0	0	0	113356	8279	0	82265	93080	296981
U_Clar	0	0	0	0	0	0	0	108340	8977	0	49045	74553	240916
M_Clar	0	0	0	0	0	0	0	105948	251371	0	149649	54096	561065
L_Clar	107213	1848	96361	3177	0	0	0	1688256	1184475	505468	368262	525941	4481002
Revilla	14887	2538	0	0	0	0	0	1048299	0	0	0	0	1065724
Union	0	0	0	0	0	0	0	827373	0	0	470904	0	1298277
Fox	56410	469	53418	1796	2229	40182	0	293707	32960	0	0	0	481171
Term101	0	0	0	0	0	0	0	248713	0	0	0	0	248713
Term105	0	0	0	0	0	0	0	0	0	0	2580662	0	2580662
Term108	0	0	0	0	0	0	0	0	0	0	0	746693	746693
Total Catch	1675751	33225	876821	16419	2617	405347	0	9449341	5785469	6787173	6296965	2839430	34168560
Escapement	634087	92350	277552	36550	39475	16699000	0	5424125	2351593	7477890	3111480	1409480	37553580
Total Run	2309838	125575	1154373	52969	42092	17104350	0	14873470	8137061	14265060	9408445	4248910	71722140
Expl Rate	72.6	26.5	76.0	31.0	6.2	2.4	0.0	63.5	71.1	47.6	66.9	66.8	47.6

Appendix H.13 1994 Pink salmon catch by stock.

Fishery	Skeena	A4-Is.	A3-In	A3-Out	Area 5	South	Yakoun	US101	US102	US103/	US105/6	US107/8	Total
Langara	8049	99	1291	32	29	0	2704	49072	3483	12307	0	0	77065
1TN	12149	55	1113	11	23	0	808	107937	25023	2773	11579	28592	190064
1TS	1451	304	693	153	180	0	4234	13033	2230	7366	0	0	29647
Masset	0	0	0	0	0	0	47	0	0	0	0	0	47
3X	14578	47	4460	55	56	0	0	32383	3377	0	0	0	54957
3Y+7	29864	177	34454	504	0	0	0	270985	14921	0	0	0	350905
3Z-7	7178	52	4679	0	0	0	0	17086	0	0	0	0	28995
4W	38966	92	2286	7	29	0	0	53389	0	0	0	0	94768
4X	27480	107	202	1	85	0	0	6703	0	0	0	0	34579
4Y	27768	0	0	0	0	0	0	0	0	0	0	0	27768
4Z	64681	0	0	0	0	0	0	0	0	0	0	0	64681
Area_5	19895	0	601	0	0	0	0	21033	0	0	0	0	41529
Noyes	47155	2563	17892	1838	0	0	0	1189830	1504817	1986517	1091102	850841	6692555
Dall	48231	1983	17659	1616	0	0	52690	2198143	1292843	1014631	928061	832433	6388288
Cordova	601	493	0	0	0	0	0	399789	418009	250749	324394	220276	1614310
Sumner	0	0	0	0	0	0	0	29480	4925	0	19196	12624	66225
U_Clar	0	0	0	0	0	0	0	71168	29055	0	181302	128811	410337
M_Clar	0	0	0	0	0	0	0	65129	188365	0	137673	91211	482379
L_Clar	6911	151	5263	688	0	0	0	390731	349549	151714	134184	143663	1182855
Revilla	51655	225	0	0	0	0	0	792907	0	0	0	0	844787
Union	0	0	0	0	0	0	0	171454	0	0	203390	0	374844
Fox	2926	188	9474	1535	2349	0	0	220214	22929	0	0	0	259614
Term101	0	0	0	0	0	0	0	999	0	0	0	0	999
Term105	0	0	0	0	0	0	0	0	0	0	82256	0	82256
Term108	0	0	0	0	0	0	0	0	0	0	0	208540	208540
Total Catch	409539	6536	100068	6440	2752	0	60483	6101465	3859526	3426057	3113137	2516992	19602990
Escaperment	202415	49050	127830	27526	44725	0	818610	4949743	2036528	6220650	2867670	1531280	18876030
Total Run	611954	55586	227898	33966	47477	0	879093	11051210	5896054	9646707	5980807	4048272	38479020
Expl Rate	66.9	11.8	43.9	19.0	5.8	0.0	6.9	55.2	65.5	35.5	52.1	62.2	50.9

## Appendix H.14 1995 Pink salmon catch by stock.

Fishery	Skeena	A4-Is.	A3-In	A3-Out	Area 5	South	Yakoun	US101	US102	US103/	US105/6	US107/8	Total
Langara	55232	200	3931	14	49	51783	0	50943	2257	5812	0	0	170221
1TN	128989	399	5528	108	160	25807	0	153007	54909	5058	21038	29197	424199
1TS	196262	9452	27605	2821	3535	72950	0	391456	37327	118461	0	0	859868
Masset	0	0	0	0	0	0	0	0	0	0	0	0	0
3X	567795	2642	105965	764	1212	92555	0	344019	121022	0	0	0	1235974
3Y+7	729160	4225	268568	5748	0	0	0	1023218	186731	0	0	0	2217651
3Z-7	163109	646	59333	0	0	0	0	114162	0	0	0	0	337250
4W	204077	376	4908	32	208	27846	0	46130	0	0	0	0	283577
4X	124094	1135	378	7	575	13047	0	6239	0	0	0	0	145476
4Y	529551	0	0	0	0	0	0	0	0	0	0	0	529551
4Z	527372	0	0	0	0	0	0	0	0	0	0	0	527372
Area_5	118357	1118	2624	89	1696	51893	0	57313	0	0	0	0	233089
Noyes	113276	7834	18805	3112	0	0	0	1107060	1195528	2149924	551012	291500	5438051
Dall	160862	11063	50742	8628	0	21984	0	3685205	2172772	1825333	872985	480633	9290207
Cordova	5224	2040	0	0	0	0	0	724124	346135	231519	152077	77547	1538665
Sumner	0	0	0	0	0	0	0	109734	4809	0	26042	13139	153725
U_Clar	0	0	0	0	0	0	0	306608	21348	0	105881	66609	500446
M_Clar	0	0	0	0	0	0	0	336663	344225	0	170805	100103	951796
L_Clar	155830	4434	79563	8349	0	0	0	4516189	2657661	1075614	726494	503504	9727637
Revilla	673088	7149	0	0	0	0	0	4538495	0	0	0	0	5218732
Union	0	0	0	0	0	0	0	169504	0	0	90210	0	259714
Fox	59686	916	49579	3327	7405	31829	0	580268	56320	0	0	0	789331
Term101	0	0	0	0	0	0	0	228	0	0	0	0	228
Term105	0	0	0	0	0	0	0	0	0	0	763612	0	763612
Term108	0	0	0	0	0	0	0	0	0	0	0	132337	132337
Total Catch	4511964	53629	677528	32999	14841	389694	0	18260560	7201044	5411720	3480156	1694569	41728710
Escapement	1607957	165756	300917	48100	90900	12648000	0	8703955	1942783	7918273	3288890	1253473	37969000
Total Run	6119921	219385	978445	81099	105741	13037690	0	26964520	9143826	13329990	6769046	2948042	79697710
Expl Rate	73.7	24.5	69.3	40.7	14.0	3.0	0.0	67.7	78.8	40.6	51.4	57.5	52.4